

nobilia[®]

Badmagazin Bathroom magazine

BADWELTEN MIT STIL
BATHROOM WORLDS WITH STYLE



Badneuheiten

Bathroom innovations



Gibt es ein besseres Gefühl, als frisch in den Tag zu starten? Ist das Bad morgens ein belebender Ort, den man voller Energie verlässt, wird es abends zu einer Oase der Entspannung und des Wohlfühls. Hier können wir in aller Ruhe durchatmen und den Tag gepflegt ausklingen lassen. Unsere Badmöbel sind von diesen angenehmen Ritualen inspiriert. Sie folgen dem Rhythmus des Tages und erfüllen selbst individuellste Ansprüche. Vom Leben inspiriert. Für Menschen gemacht.

Is there any better feeling than starting the day feeling fresh? If the bathroom is an invigorating place in the morning, that you leave full of energy, in the evening it becomes an oasis of relaxation and well-being. Here, we can take a deep breath in peace and see out the day in a cultivated manner. Our bathroom furniture is inspired by these pleasant rituals. It follows the rhythm of the day and fulfils even the most individual of demands. Inspired by life. Made for people.

4 **Bad ganz persönlich** Bathrooms made personal

10 **Badwelten** Bathroom worlds

64 **Planungsvorschläge** Planning suggestions

87 **Dekore und Griffe** Décors and handles

Bad ganz persönlich

Bathrooms made personal



Schneller Durchstarter oder Wellnessfan? Typgerechte Bäder punkten mit ästhetischen Designs, smarter Funktionalität und Kombinationsmöglichkeiten, die so ziemlich jeder Raumgröße gerecht werden.

—
A fast go-getter or a wellness fan? Bathrooms to suit your personality that appeal with aesthetically-pleasing designs, smart functionality and combination possibilities that suit any size of room.





**FÜR BESONDERS VIEL
SPASS IM BAD.**
FOR LOTS OF FUN
IN THE BATHROOM.



**AUF DIE PLÄTZE,
FERTIG, BAD!**
ON YOUR MARKS,
GET SET, BATHROOM!

Das passende Bad erfreut jeden Tag mit seiner unkomplizierten Vielseitigkeit und einem schönen Look. Praktisch im Alltag. Für uns. Für mich.

The right bathroom will delight you every single day with its simple versatility and beautiful look. Practical in everyday life. For us. For me.



**DURCHATMEN UND
AUFTANKEN.**
BREATHE AND
RECHARGE YOUR
BATTERIES.

Genuss pur! Tür zu und ein ganz persönliches Wellnessprogramm zuhause genießen. Diese Momente geben jedem Tag etwas Besonderes.

Pure pleasure! Close the door and enjoy your own personal wellness programme at home. These moments make every single day feel a bit special.



**AUS ALLTAG WIRD
ENTSPANNUNG.**
EVERYDAY LIFE MELTS
INTO RELAXATION.



**WENN ALLES IM RICHTIGEN
LICHT ERSCHEINT.**
WHEN EVERYTHING SHINES
IN THE RIGHT LIGHT.





12
Warm und natürlich
 warm grove

32
Soft Touch
 soft touch



24
Urban und industriell
 deep industrial



Trends Trends

Unser Sortiment hochwertig verarbeiteter Badmöbel bietet Ihnen völlige Kombinations- und Gestaltungsfreiheit. Ihr Bad können Sie aus vier aktuellen Lifestyle-Trends auswählen oder diese auch untereinander kombinieren. Immerhin geht es um nicht weniger als Ihr persönliches Wunschbad.

Our range of high quality bathroom furniture offers complete freedom in terms of design and different combinations. You can choose your bathroom from four current lifestyle trends or even combine them. After all, this is about nothing less than your personal dream bathroom.



52
Licht und Glanz
 reflecting light





Warm und natürlich

Nicht nur die Optik, auch die Struktur von Holz bringt Leben und Atmosphäre in jedes Bad.

—
It is not just the look but also the structure of wood that brings life and atmosphere to every bathroom.

warm grove



ANTI
FINGER
PRINT**EASYTOUCH****967 Lacklaminat, Alpinweiß ultramatt**

967 Lacquered laminate, alpine white ultra matt



NATÜRLICH FRISCH NATURALLY FRESH

Kontrastreich und dennoch mit einer ruhigen Ausstrahlung! Die Nussbaum-Optik und die alpinweiße Oberfläche mit Anti-Fingerprint-Beschichtung harmonieren perfekt mit der Waschtischfläche aus coolem Quarzstein. Schöne Lösung: Dank des offenen Regals finden auch Handtücher ihren Platz und sind schnell griffbereit. Zusätzlichen Komfort bietet die praktische Hakenleiste in der Nische.

Rich in contrasts yet exudes calm! The walnut appearance and alpine white surface with anti-fingerprint coating harmonises perfectly with the hand basin surface made from cool quartz stone. Beautiful solution: thanks to the open shelf units, even hand towels have a place and are quickly to hand. The practical hook rail in the niche offers additional convenience.

STRUCTURA

405 Eiche Sierra Nachbildung
405 Sierra oak reproduction



STRUKTURGEBEND A SENSE OF STRUCTURE

**Mal harmonisch, mal als angenehmer Kontrast:
Die naturbelassene Optik der Eiche Sierra bringt
Struktur in viele Raum-Architekturen und sorgt
für einen frischen, warmen Look.**

Sometimes coordinated, sometimes contrasting.
The natural look of the Sierra oak lends a sense
of structure to the architecture of many rooms
and ensures a fresh, warm look.

STRUCTURA

403 Eiche Nero Nachbildung
403 Nero oak reproduction



SOUVERÄN
SOPHISTICATED

Das matte Schwarz der Eiche Nero strahlt eine selbstbewusste Eleganz aus und inszeniert Stauraum modern-minimalistisch. Praktisches Detail: der Handtuchhalter.

The matt black of the Nero oak radiates a self-confident elegance and showcases the storage space in a modern and minimalistic way. Practical detail: the towel rail.





WOHNLICH-WARM COSY AND WARM

Diese dunklere und naturbelassen gemaserte Optik der Eiche Havanna setzt angenehm warme Kontraste in ansonsten kühl gehaltenen Bädern.

The dark and untreated grained look of the Havana oak provides beautiful warm contrasts in an otherwise cool-looking bathroom.



STRUCTURA

402 Eiche Havanna Nachbildung
402 Havana oak reproduction



**INLINE**

551 Lack, Alpinweiß matt
551 Lacquer, honed alpine white

RIVA

887 Eiche Somerset Nachbildung
887 Somerset oak reproduction



IN KOMBINATION IN COMBINATION

Holz-Optiken und unifarbene Fronten sorgen zusammen immer für einen sehr eigenständigen Look. Die Kombination aus unserer hellen Eiche Somerset und mattweißen Fronten sorgt zum Beispiel für eine besondere Leichtigkeit. Farbige Fronten mit Eiche Havanna kreieren hingegen eine frische und moderne Optik.

Wood looks and solid coloured fronts always create a unique impression when used together. The combination of our light Somerset oak and the matt white fronts, for example, create an air of special lightness. Coloured fronts with Havana oak, by contrast, give rise to a fresh and modern look.

TOUCH

337 Lacklaminat, Aqua supermatt
337 Lacquered laminate, aqua supermatt



Urban und industriell deep industrial



So schön können Stauraumlösungen im Bad inszeniert werden. Der Beton-Look, aber auch die Schiefer-Optiken in unterschiedlichen Graunüancen kultivieren im Bad einen cleanen, urbanen Style.

—
This is how beautiful storage space solutions in the bathroom can be. The concrete look and also the slate appearance in various shades of grey cultivate a clean, urban style in the bathroom.





PURE OFFENHEIT PURE OPENNESS

Das offene Stollenregal-System lässt sich in unterschiedlichen Dimensionen planen und sorgt für ein wohnliches Ambiente, das durch Oberflächen in Beton-Optik in warmem Terragrau noch unterstrichen wird.

The open pole-mounted shelving system can be designed in various dimensions and ensures a homely ambience, which is further emphasised by concrete-look surfaces in warm Terra grey.

RIVA

839 Beton Terragrau Nachbildung
839 Concrete Terra grey reproduction

CLEANER LOOK CLEAN LOOK

Clean und aufgeräumt wirkt die grifflose Planung in steingrauer Optik. Schönes Detail: die integrierte Lichtleiste sorgt für dezente Effekte.

The handleless design in a stone grey appearance looks clean and tidy. Beautiful detail: the integrated lighting strip creates subtle effects.



STONEART

304 Schiefer steingrau Nachbildung
304 Stone grey slate reproduction



RIVA

892 Beton grau Nachbildung
892 Concrete grey reproduction

BETON STYLE CONCRETE STYLE

Der große Trend Beton-Look hat sich in den letzten Jahren weltweit etabliert. Zu Recht, denn die kühle Eleganz passt hervorragend in jedes moderne Badezimmer.

The big concrete look trend has established itself globally over the past few years. And rightly so, because its cool elegance perfectly suits a modern bathroom.





Soft Touch

soft
touch

Zeitlos hochwertig: Nicht nur in kleinen Räumen entfalten matte Oberflächen ihre ruhige Wirkung.

—
Timelessly high quality: matt surfaces have a calming effect, and not just in small spaces.





RUNDUM COOL

ALL ROUND COOLNESS

Schwarze Badmöbel sind ein echtes Trendthema. Sehr cool wirken die matten Oberflächen im Kontrast zum Vitrinenschrank Flat mit ultraschmalem Aluminiumrahmen. Runde Abschlusswangen sorgen für einen wohnlichen Charakter.

Black bathroom furniture is very on trend. The matt surfaces look very cool in contrast to the glass cabinet Flat with ultra slim aluminium frame, while round end upright panel provide a homely character.

TOUCH

340 Lacklaminat, Schwarz supermatt
340 Lacquered laminate, black supermatt

SCHÖNER LOOK BEAUTIFUL LOOK

Der großzügige Spiegelschrank mit seiner optionalen, eleganten Aufsatzleuchte überzeugt mit seinem praktischen Innenleben. Ein echter Hingucker!

The spacious mirrored cabinet with its optional, elegant top light appeals with its practical interior. A real eye-catcher!



FASHION

165 Lack, Steingrau matt
165 Lacquer, honed stone grey





TOUCH

340 Lacklaminat, Schwarz supermatt
340 Lacquered laminate, black supermatt



MATT KOMBINIERT
MATT COMBINED

Matte, cleane Fronten setzen in Kombination mit Eiche-Optiken angenehme Kontraste und schaffen Struktur. Die Innenorganisation punktet mit einem integrierten Abfallsammler.

—
Matt, clean fronts in combination with an oak appearance give rise to pleasant contrasts and create structure. The interior organisation impresses with its integrated waste bin.



EFFEKTIVOLL
EFFECTIVE

Frei schwebend oder mit Sockelfüßen als Gestaltungsmerkmal, mit farblich abgesetzten Arbeitsplatten, durchgehenden Griffleisten oder der pflegeleichten Anti-Fingerprint-Beschichtung: Gerade bei matten Fronten machen die Details einen Raum zu Ihrem ganz eigenen Bad.

Free floating elements or with pedestal feet as a design feature, with contrasting colour counters, continuous handles or the easy care anti-fingerprint coating: with matt fronts in particular, it's the detail that turns a room into your very own bathroom.

TOUCH

340 Lacklaminat, Schwarz supermatt
340 Lacquered laminate, black supermatt



ANTI FINGER PRINT

EASYTOUCH

963 Lacklaminat, Rostrot ultramatt
963 Lacquered laminate, rust red ultra matt



MEHR EXKLUSIVITÄT MORE EXCLUSIVITY

Eine sehr ästhetische Planung mit Wow-Effekt, die mit einer besonders hochwertigen Material-Kombination aus alpinweißen ultramatten Oberflächen, einer dunklen Quarzsteinplatte und einem Waschtisch aus Mineralguss überzeugt. Einfach großartig!

A very aesthetically-pleasing design with the wow factor that impresses with its particularly high-quality material combination of ultra matt alpine white surfaces, a dark quartz stone top and cast mineral hand basin. Simply amazing!



EASYTOUCH

967 Lacklaminat, Alpinweiß ultramatt

967 Lacquered laminate, alpine white ultra matt



ORDNUNG PUR PURE ORDER

Eine perfekte und praktische Lösung für das Gäste-WC: Schrankelemente mit geringer Tiefe, die wir extra für kleine Räume entwickelt haben. Zusätzlichen Komfort bietet die pflegeleichte ultramatte Oberfläche mit Anti-Fingerprint für einen cleanen Look ohne Fingerabdrücke.

A perfect and practical solution for the guest WC: low-depth unit elements that we developed especially for small rooms. Additional comfort is provided by the easy-to-clean, ultra matt surface with anti-fingerprint coating for a clean look without fingerprints.

EASYTOUCH

969 Lacklaminat, Sand ultramatt

969 Lacquered laminate, sand ultra matt





ELEGANTE OPTIK ELEGANT APPEARANCE

Individuelle Schrankelemente in einer außergewöhnlichen Glasoptik mit leicht metallischem Schimmer spielen bei dieser Bad-Planung die zentrale Rolle. Ein cooler und zeitloser Look mit visuellem Tiefeneffekt.

Individual unit elements in an exceptional glass appearance with a slightly metallic shimmer play a central role in this bathroom design. A cool and timeless look with visual depth effect.



ARTIS

937 Glasoptik, Titanio matt
937 Glass appearance, Titanio matt



NORDIC

—
782 Lack, Weiß matt
 782 Lacquer, honed white

MODERNE GEMÜTLICHKEIT
 MODERN COSINESS

Eine harmonische Planung für Familien, die modernes Landhaus-Design lieben und viel Wert auf Stauraum legen. Offene Regale in mattem Schwarz und individuelle Beleuchtungsdetails sorgen für einen kreativen Look. Besonders praktisch im Alltag: der smarte Wäscheschrank.

—
 A harmonious design for families who love the modern cottage style and attach great importance to storage space. Open shelf units in black matt and individual lighting details ensure a creative look. Particularly practical for everyday life: the smart laundry unit.





CASCADA

774 Lacklaminat, Weiß

774 Lacquered laminate, white

CASCADA

772 Lacklaminat, Steingrau

772 Lacquered laminate, stone grey

LANDHAUSSTIL COUNTRY HOUSE STYLE

Mit facettierten, matten Fronten gestalten Sie einen gemütlichen bis lässigen Scandi-Look in Ihrem Bad. Eine integrierte Lichtleiste am Waschbecken sorgt für besondere Effekte.

With framed matt fronts, you can design a cosy to casual Scandinavian look in your bathroom. An integrated lighting strip on the hand basin provides special effects.





Licht und Glanz

reflecting light

Mehr Licht, mehr Raum: Hochglänzende Oberflächen erzeugen optische Tiefe und vergrößern damit das Bad.

—
More light, more space: high gloss surfaces create visual depth and make the bathroom appear larger.

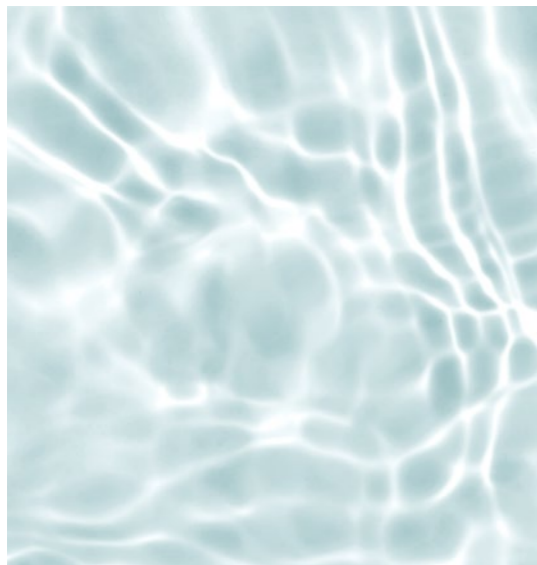



FRISCHEKICK A FRESHNESS BOOST

Die alltagstaugliche Planung mit hochglänzenden Badmöbeln in Alpinweiß wirkt frisch und lässt sich – je nach Raumgröße – vielseitig stylen. Der Doppelwaschtisch bietet viel Platz für Familien und bekommt durch den runden Wangenabschluss seinen individuellen Charakter.

The everyday design with high-gloss bathroom furniture in alpine white looks fresh and – depending on the size of the room – can be styled in many different ways. The double hand basin offers lots of space for families and gains its individual character thanks to the round end uprights.

FLASH

503 Lacklaminat, Alpinweiß Hochglanz
503 Lacquered laminate, alpine white high gloss



STIMMUNGEN MOODS

Mehr Kontraste für eine frische Wohnlichkeit. Schwarz trifft Weiß und Hochglanz-Fronten werden durch matte Metallkufen und cleane Griffe ergänzt. Ein besonders ästhetisches Detail sind die schwarzen Armaturen. Schöne Alternative: die Kombination mit einem Smartcube in Holz-Optik für das Gäste-WC.

More contrasts for a fresh homeliness. Black meets white and high gloss fronts are complemented by matt metal runners and clean handles. The black taps are a particularly aesthetically-pleasing detail. Beautiful alternative: the combination with a Smartcube in wood appearance for the guest WC.



FLASH

503 Lacklaminat, Alpinweiß Hochglanz

503 Lacquered laminate, alpine white high gloss





LUX

—
817 Lack, Alpinweiß Hochglanz
 817 Lacquer, alpine white high gloss



FLASH

—
503 Lacklaminat, Alpinweiß Hochglanz
 503 Lacquered laminate, alpine white high gloss

BLICKFANG
 EYE-CATCHER

Hochglänzende Badmöbel setzen im wahrsten Sinne des Wortes Highlights. In Weiß und angenehm ausgeleuchtet, sorgen sie zudem für eine sehr offene Raumarchitektur.

—
 High gloss bathroom furniture is a highlight in the true sense of the word. In white and pleasantly illuminated, it also creates a very open architecture within the room.



HOCHGLANZ HIGH GLOSS

Mit glänzenden Oberflächen erreichen Sie einen sehr hochwertigen Look in Ihrem Bad und sorgen gleichzeitig für eine optische Vergrößerung des Raums.

By using shiny surfaces, you can achieve a very high quality look in your bathroom and at the same time make it look larger.

FLASH

455 Lacklaminat, Seidengrau Hochglanz
455 Lacquered laminate, satin grey high gloss



LUX

817 Lack, Alpinweiß Hochglanz
817 Lacquer, alpine white high gloss



OPTISCHE TIEFE VISUAL DEPTH

Kleinere Bäder brauchen andere Planungen als große. Und andere Möbel. Unsere Bad-Elemente bieten hierfür einen entsprechenden Gestaltungsspielraum: hochglänzende Fronten eignen sich ideal für kleinere Bäder, kommen aber auch in größeren Räumen voll zur Geltung.

Smaller bathrooms need different designs to larger ones. And different furniture. Our bathroom elements offer the appropriate design scope for this: high gloss fronts are ideal for smaller bathrooms, but also come into their own in larger rooms.



FLASH

453 Lacklaminat, Schiefergrau Hochglanz
453 Lacquered laminate, slate grey high gloss



LUX

819 Lack, Seidengrau Hochglanz
819 Lacquer, satin grey high gloss



PLANUNGSVORSCHLÄGE

PLANNING SUGGESTIONS

Unsere Badmöbel können Sie immer individuell und passend für Ihre Bedürfnisse kombinieren. Ihr Fachhändler vor Ort unterstützt Sie gerne bei der Planung.

You can always combine our bathroom furniture individually to suit your needs. Your local dealer would be happy to help you with your plans.

grifflos handleless

Waschtischgröße Hand basin size
600 mm

NBSET60-001

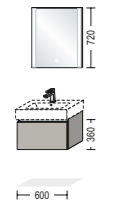

NBSET60-001

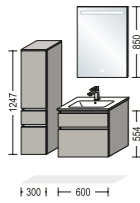

NBSET60-004

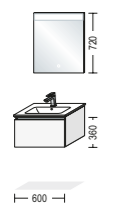

NBSET60-005

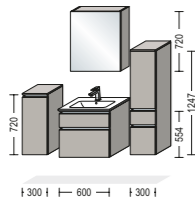

800 mm

NBSET80-002

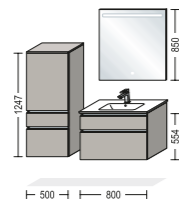

NBSET80-003

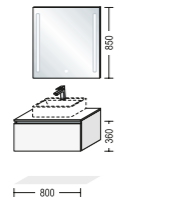

NBSET80-004

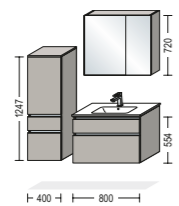

NBSET80-005

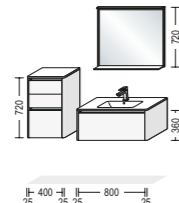

900 mm

NBSET90-001

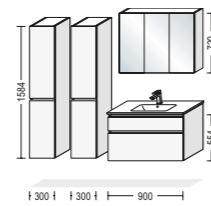

NBSET90-002

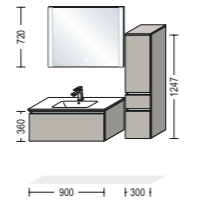

1000 mm

NBSET100-002

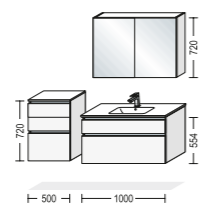

NBSET100-006

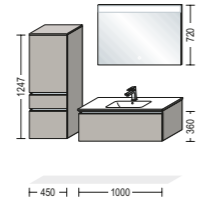

NBSET100-007

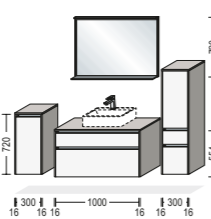

1200 mm

NBSET120-003

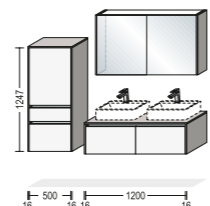

NBSET120-004

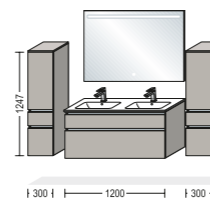

NBSET120-005

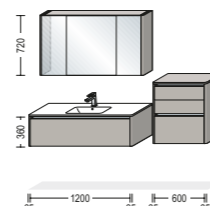

NBSET120-006

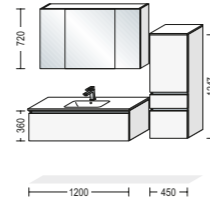

1500 mm

NBSET150-001

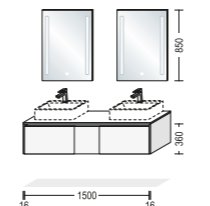

NBSET150-003

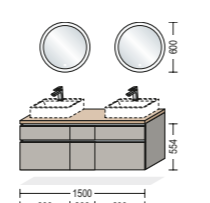

mit Griff with handle

Waschtischgröße Hand basin size
400 mm

BGSET40-001

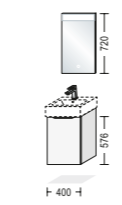

600 mm

BGSET60-001

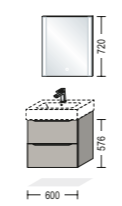

BSET60-001



BSET60-002

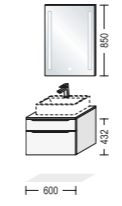

BSET60-004



BSET60-005



800 mm

BSET80-002

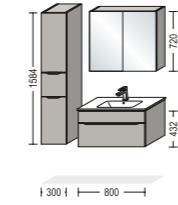

BSET80-006

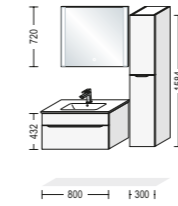

BSET80-007

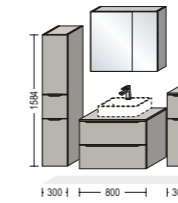

BSET80-008



900 mm

BSET90-001

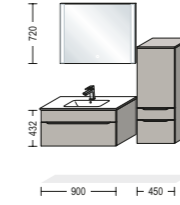

BSET90-002

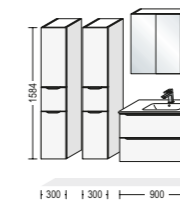

1000 mm

BSET100-001

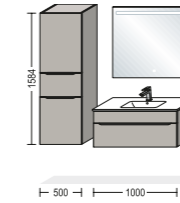

BSET100-004

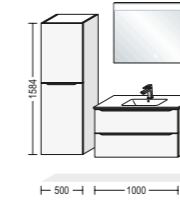

BSET100-005

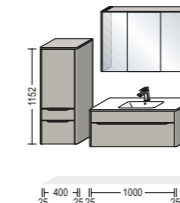

BSET100-006

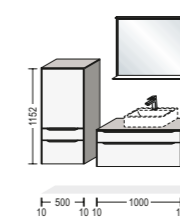

1200 mm

BSET120-003

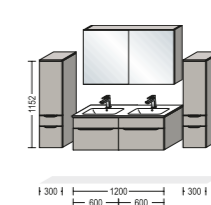

BSET120-004

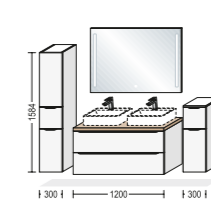

BSET120-005

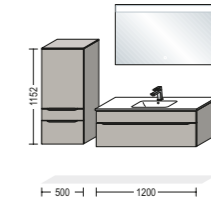

BSET120-006

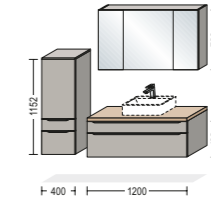

BSET120-007

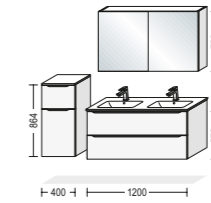

1500 mm

BSET150-002

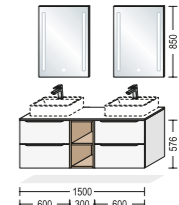

BSET150-003

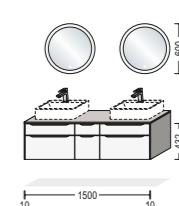

SPEZIFIKATIONEN SPECIFICATIONS

grifflos handleless

Waschtischgröße Hand basin size

600 mm



NBSET60-001

mit Gäste-Waschtischschrank 350 mm tief
with guest vanity unit, 350 mm deep

1 × NBWBAG 60-36

Badezimmer-Waschtischschrank, 1 Innenblende, 1 Auszug, 350 mm tief, 600 mm breit, 360 mm hoch
Bathroom vanity unit, 1 internal panel, 1 pull-out, 350 mm deep, 600 mm wide, 360 mm high

1 × 87731

Waschtisch CUBO 63, 390 mm tief, 630 mm breit, 120 mm hoch
Hand basin CUBO 63, 390 mm deep, 630 mm wide, 120 mm high

1 × 17713

Geberit Tauchrohrgeruchverschluss
Geberit dip pipe odour trap

1 × SP-EMMA 60

Spiegel EMMA TOUCH mit LED Beleuchtung, 25 mm tief, 600 mm breit, 720 mm hoch
Mirror EMMA TOUCH with LED lights, 25 mm deep, 600 mm wide, 720 mm high

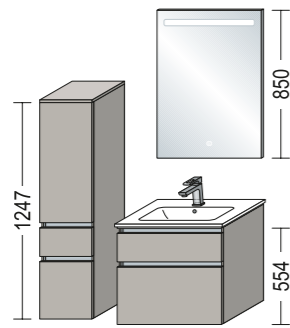
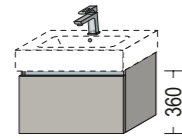

NBSET60-001

1 × NBMSA 30-125

Badezimmer-Midischrank, 1 Tür, 1 Schubkasten, 1 Auszug, 2 Einlegeböden, 350 mm tief, 300 mm breit, 1247 mm hoch
Bathroom Midi unit, 1 door, 1 drawer, 1 pull-out, 2 shelves, 350 mm deep, 300 mm wide, 1247 mm high

1 × ADB 16-38

Abdeckboden, 16 mm stark, 373 mm tief, 303 mm breit
Top shelf, 16 mm thick, 373 mm deep, 303 mm wide

1 × NBWA 60-55

Badezimmer-Waschtischschrank, 1 feste Blende, 1 Auszug 461 mm tief, 600 mm breit, 554 mm hoch
Bathroom vanity unit, 1 fixed panel, 1 pull-out, 461 mm deep, 600 mm wide, 554 mm high

1 × 87706

Waschtisch MEGX 600C, 492 mm tief, 614 mm breit, 142 mm hoch
Hand basin MEGX 600C, 492 mm deep, 614 mm wide, 142 mm high

1 × SPLH 60

Spiegel mit horizontalem LED-Lichtfenster, 24 mm tief, 600 mm breit, 850 mm hoch
Mirror with horizontal LED light window, 24 mm deep, 600 mm wide, 850 mm high

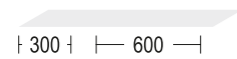

NBSET60-004

1 × NBWBA 60-36

Badezimmer-Waschtischschrank, 1 Innenblende, 1 Auszug, 461 mm tief, 600 mm breit, 360 mm hoch
Bathroom vanity unit, 1 internal panel, 1 pull-out, 461 mm deep, 600 mm wide, 360 mm high

1 × 87746

Waschtisch MAX 610, 487 mm tief, 610 mm breit, 140 mm hoch
Hand basin MAX 610, 487 mm deep, 610 mm wide, 140 mm high

1 × SP-DEV 60

Spiegel DEVA TOUCH mit LED Beleuchtung, 25 mm tief, 600 mm breit, 720 mm hoch
Mirror DEVA TOUCH with LED lights, 25 mm deep, 600 mm wide, 720 mm high

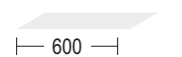
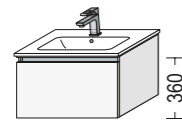

Waschtischgröße Hand basin size

600 / 800 mm

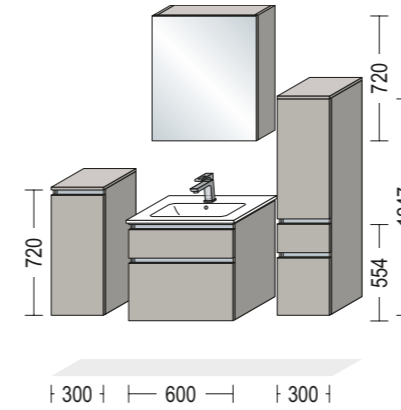

NBSET60-005

1 × NBS 30-72

Badezimmer-Sideboard, 1 Tür, 2 Einlegeböden, 350 mm tief, 300 mm breit, 720 mm hoch
Bathroom sideboard, 1 door, 2 shelves, 350 mm deep, 300 mm wide, 720 mm high

1 × ADB 16-38

Abdeckboden, 16 mm stark, 373 mm tief, 303 mm breit
Top shelf, 16 mm thick, 373 mm deep, 303 mm wide

1 × NBWA 60-55

Badezimmer-Waschtischschrank, 1 feste Blende, 1 Auszug, 461 mm tief, 600 mm breit, 554 mm hoch
Bathroom vanity unit, 1 fixed panel, 1 pull-out, 461 mm deep, 600 mm wide, 554 mm high

1 × 87736

Waschtisch LAVABO BLOB 600, 492 mm tief, 605 mm breit, 171 mm hoch
Hand basin LAVABO BLOB 600, 492 mm deep, 605 mm wide, 171 mm high

1 × WBSP 60-1

Spiegelschrank, 1 Spiegeltür, 2 Glaseinlegeböden, 202 mm tief, 600 mm breit, 720 mm hoch
Mirrored bathroom cabinet, 1 mirrored door, 2 glass shelves, 202 mm deep, 600 mm wide, 720 mm high

1 × NBMSA 30-125

Badezimmer-Midischrank, 1 Tür, 1 Schubkasten, 1 Auszug, 2 Einlegeböden, 350 mm tief, 300 mm breit, 1247 mm hoch
Bathroom Midi unit, 1 door, 1 drawer, 1 pull-out, 2 shelves, 350 mm deep, 300 mm wide, 1247 mm high

1 × ADB 16-38

Abdeckboden, 16 mm stark, 373 mm tief, 303 mm breit
Top shelf, 16 mm thick, 373 mm deep, 303 mm wide

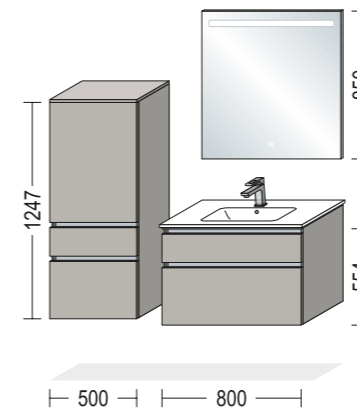

NBSET80-002

1 × NBMSA 50-125

Badezimmer-Midischrank, 1 Tür, 1 Schubkasten, 1 Auszug, 2 Einlegeböden, 350 mm tief, 500 mm breit, 1247 mm hoch
Bathroom Midi unit, 1 door, 1 drawer, 1 pull-out, 2 shelves, 350 mm deep, 500 mm wide, 1247 mm high

1 × ADB 16-38

Abdeckboden, 16 mm stark, 373 mm tief, 503 mm breit
Top shelf, 16 mm thick, 373 mm deep, 503 mm wide

1 × NBWA 80-55

Badezimmer-Waschtischschrank, 1 feste Blende, 1 Auszug, 461 mm tief, 800 mm breit, 554 mm hoch
Bathroom vanity unit, 1 fixed panel, 1 pull-out, 461 mm deep, 800 mm wide, 554 mm high

1 × 87708

Waschtisch MEGX 800C, 492 mm tief, 814 mm breit, 142 mm hoch
Hand basin MEGX 800C, 492 mm deep, 814 mm wide, 142 mm high

1 × SPLH 80

Spiegel mit horizontalem LED-Lichtfenster, 24 mm tief, 800 mm breit, 850 mm hoch
Mirror with horizontal LED light window, 24 mm deep, 800 mm wide, 850 mm high



NBSET80-003

1 × NBWA 80-36

Badezimmer-Waschtischschrank, 461 mm tief, 800 mm breit, 360 mm hoch
Bathroom vanity unit, 461 mm deep, 800 mm wide, 360 mm high

1 × ADB 16-49

Abdeckboden, 16 mm stark, 484 mm tief, 803 mm breit
Top shelf, 16 mm thick, 484 mm deep, 803 mm wide

1 × SPLV 80

Spiegel mit vertikalen LED-Lichtfenstern, 24 mm tief, 800 mm breit, 850 mm hoch
Mirror with vertical LED light windows, 24 mm deep, 800 mm wide, 850 mm high



Die Planungsvorschläge enthalten keine Aufsatzwaschtische, Armaturen, Leuchten, Steckdosen oder Ausschnitte in Schubkästen und Abdeckböden. Diese müssen zusätzlich zur Set-Artikelnummer bestellt werden.

The design suggestions do not contain any surface-mounted hand basins, taps, lights, sockets or cut-outs in drawers and top shelves. These must be ordered in addition to the set item number.

Die Planungsvorschläge enthalten keine Aufsatzwaschtische, Armaturen, Leuchten, Steckdosen oder Ausschnitte in Schubkästen und Abdeckböden. Diese müssen zusätzlich zur Set-Artikelnummer bestellt werden.

The design suggestions do not contain any surface-mounted hand basins, taps, lights, sockets or cut-outs in drawers and top shelves. These must be ordered in addition to the set item number.

SPEZIFIKATIONEN SPECIFICATIONS

grifflos handleless

Waschtischgröße Hand basin size

800 mm

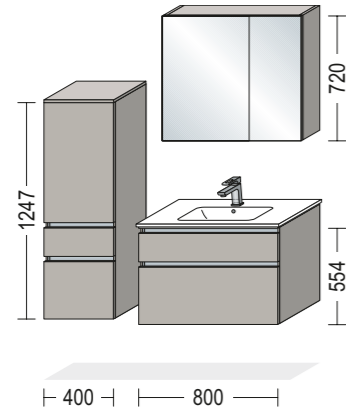

NBSET80-004

1 × NBMSA 40-125

Badezimmer-Midischrank, 1 Tür, 1 Schubkasten, 1 Auszug, 2 Einlegeböden, 350 mm tief, 400 mm breit, 1247 mm hoch
Bathroom Midi unit, 1 door, 1 drawer, 1 pull-out, 2 shelves, 350 mm deep, 400 mm wide, 1247 mm high

1 × ADB 16-38

Abdeckboden, 16 mm stark, 373 mm tief, 403 mm breit
Top shelf, 16 mm thick, 373 mm deep, 403 mm wide

1 × NBWA 80-55

Badezimmer-Waschtischschrank, 1 feste Blende, 1 Auszug, 461 mm tief, 800 mm breit, 554 mm hoch
Bathroom vanity unit, 1 fixed panel, 1 pull-out, 461 mm deep, 800 mm wide, 554 mm high

1 × 87748

Waschtisch MAX 810, 487 mm tief, 810 mm breit, 140 mm hoch
Hand basin MAX 810, 487 mm deep, 810 mm wide, 140 mm high

1 × WBSPA 80-1

Spiegelschrank, 2 Spiegeltüren, 497/297 mm breit, 2 Glaseinlegeböden, 202 mm tief, 800 mm breit, 720 mm hoch
Mirrored bathroom cabinet, 2 mirrored doors, 497/297 mm wide, 2 glass shelves, 202 mm deep, 800 mm wide, 720 mm high

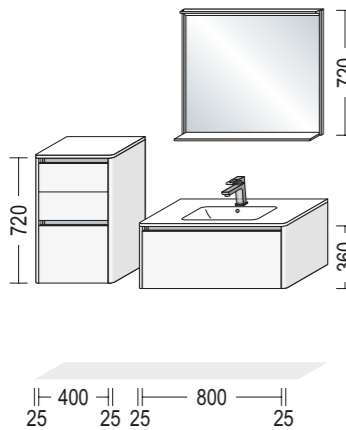

NBSET80-005

1 × NBS2SA 40-72

Badezimmer-Sideboard, 2 Schubkästen, 1 Auszug, 350 mm tief, 400 mm breit, 720 mm hoch
Bathroom sideboard, 2 drawers, 1 pull-out, 350 mm deep, 400 mm wide, 720 mm high

2 × WAR 25-72

Runde Abschlusswangen, 25 mm stark, 371 mm tief, 720 mm hoch
Round end upright panel, 25 mm thick, 371 mm deep, 720 mm high

1 × ADB 16-38

Abdeckboden, 16 mm stark, 372,5 mm tief, 453 mm breit
Top shelf, 16 mm thick, 372.5 mm deep, 453 mm wide

1 × NBWBA 80-36

Badezimmer-Waschtischschrank, 1 Innenblende, 1 Auszug, 461 mm tief, 800 mm breit, 360 mm hoch
Bathroom vanity unit, 1 internal panel, 1 pull-out, 461 mm deep, 800 mm wide, 360 mm high

2 × WAR 25-36

Runde Abschlusswangen, 25 mm stark, 482 mm tief, 360 mm hoch
Round end upright panel, 25 mm thick, 482 mm deep, 360 mm high

1 × 87741

Waschtisch NobX 860, 487 mm tief, 860 mm breit, 129 mm hoch
Hand basin NobX 860, 487 mm deep, 860 mm wide, 129 mm high

1 × 17715

Geberit Clou Ab- und Überlauf
Geberit Clou drain and overflow

1 × SPLAR 80

Spiegel mit LED-Beleuchtung, 1 Ablagefläche 111 mm tief, 146 mm tief, 800 mm breit, 720 mm hoch
Mirror with LED lights, 1 shelf 111 mm deep, 146 mm deep, 800 mm wide, 720 mm high

Waschtischgröße Hand basin size

900/1000 mm

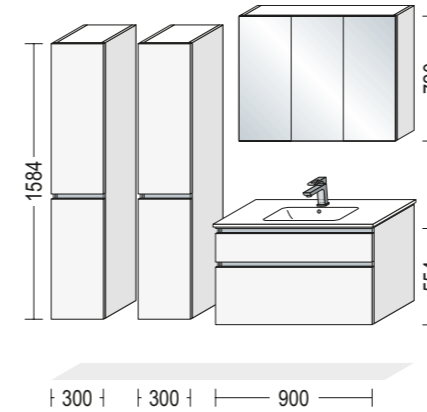

NBSET90-001

2 × NBM 30-158

Badezimmer-Midischrank, 2 Türen, 4 Einlegeböden, 350 mm tief, 300 mm breit, 1584 mm hoch
Bathroom Midi unit, 2 doors, 4 shelves, 350 mm deep, 300 mm wide, 1584 mm high

1 × NBWA 90-55

Badezimmer-Waschtischschrank, 1 feste Blende, 1 Auszug, 461 mm tief, 900 mm breit, 554 mm hoch
Bathroom vanity unit, 1 fixed panel, 1 pull-out, 461 mm deep, 900 mm wide, 554 mm high

1 × 87737

Waschtisch LAVABO BLOB 900, 492 mm tief, 905 mm breit, 171 mm hoch
Hand basin LAVABO BLOB 900, 492 mm deep, 905 mm wide, 171 mm high

1 × WBSP3 90-1

Spiegelschrank, 3 Spiegeltüren, 4 Glaseinlegeböden, 1 Mittelseite, 202 mm tief, 900 mm breit, 720 mm hoch
Mirrored bathroom cabinet, 3 mirrored doors, 4 glass shelves, 1 centre panel, 202 mm deep, 900 mm wide, 720 mm high

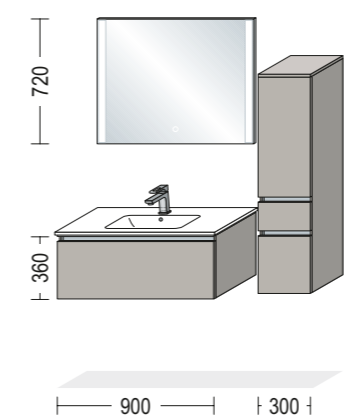

NBSET90-002

1 × NBWBA 90-36

Badezimmer-Waschtischschrank, 1 Innenblende, 1 Auszug, 461 mm tief, 900 mm breit, 360 mm hoch
Bathroom vanity unit, 1 internal panel, 1 pull-out, 461 mm deep, 900 mm wide, 360 mm high

1 × 87737

Waschtisch LAVABO BLOB 900, 492 mm tief, 905 mm breit, 171 mm hoch
Hand basin LAVABO BLOB 900, 492 mm deep, 905 mm wide, 171 mm high

1 × SP-EMMA 90

Spiegel EMMA TOUCH mit LED Beleuchtung, 25 mm tief, 900 mm breit, 720 mm hoch
Mirror EMMA TOUCH with LED lights, 25 mm deep, 900 mm wide, 720 mm high

1 × NBMSA 30-125

Badezimmer-Midischrank, 1 Tür, 1 Schubkasten, 1 Auszug, 2 Einlegeböden, 350 mm tief, 300 mm breit, 1247 mm hoch
Bathroom Midi unit, 1 door, 1 drawer, 1 pull-out, 2 shelves, 350 mm deep, 300 mm wide, 1247 mm high

1 × ADB 16-38

Abdeckboden, 16 mm stark, 373 mm tief, 303 mm breit
Top shelf, 16 mm thick, 373 mm deep, 303 mm wide

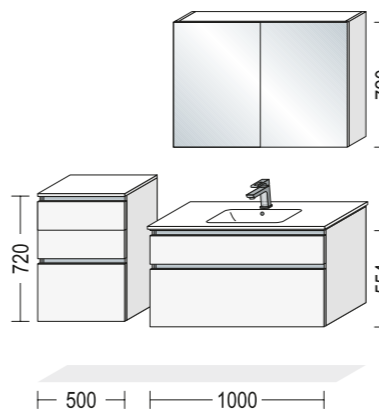

NBSET100-002

1 × NBS2SA 50-72

Badezimmer-Sideboard, 2 Schubkästen, 1 Auszug, 350 mm tief, 500 mm breit, 720 mm hoch
Bathroom sideboard, 2 drawers, 1 pull-out, 350 mm deep, 500 mm wide, 720 mm high

1 × ADB 16-38

Abdeckboden, 16 mm stark, 373 mm tief, 503 mm breit
Top shelf, 16 mm thick, 373 mm deep, 503 mm wide

1 × NBWA 100-55

Badezimmer-Waschtischschrank, 1 feste Blende, 1 Auszug, 461 mm tief, 1000 mm breit, 554 mm hoch
Bathroom vanity unit, 1 fixed panel, 1 pull-out, 461 mm deep, 1000 mm wide, 554 mm high

1 × 87710

Waschtisch MEGX 1000C, 492 mm tief, 1014 mm breit, 142 mm hoch
Hand basin MEGX 1000C, 492 mm deep, 1014 mm wide, 142 mm high

1 × WBSP 100-1

Spiegelschrank, 2 Spiegeltüren, 2 Glaseinlegeböden, 202 mm tief, 1000 mm breit, 720 mm hoch
Mirrored bathroom cabinet, 2 mirrored doors, 2 glass shelves, 202 mm deep, 1000 mm wide, 720 mm high

Die Planungsvorschläge enthalten keine Aufsatzwaschtische, Armaturen, Leuchten, Steckdosen oder Ausschnitte in Schubkästen und Abdeckböden. Diese müssen zusätzlich zur Set-Artikelnummer bestellt werden.

The design suggestions do not contain any surface-mounted hand basins, taps, lights, sockets or cut-outs in drawers and top shelves. These must be ordered in addition to the set item number.

Die Planungsvorschläge enthalten keine Aufsatzwaschtische, Armaturen, Leuchten, Steckdosen oder Ausschnitte in Schubkästen und Abdeckböden. Diese müssen zusätzlich zur Set-Artikelnummer bestellt werden.

The design suggestions do not contain any surface-mounted hand basins, taps, lights, sockets or cut-outs in drawers and top shelves. These must be ordered in addition to the set item number.

SPEZIFIKATIONEN SPECIFICATIONS

grifflos handleless

Waschtischgröße Hand basin size

1000 mm

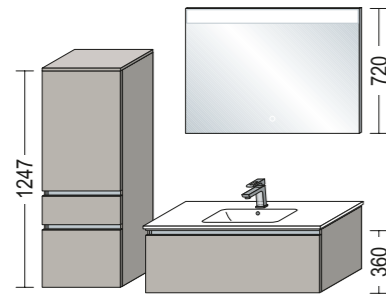

NBSET100-006

1 × NBMSA 45-125

Badezimmer-Midischrank, 1 Tür, 1 Schubkasten, 1 Auszug, 2 Einlegeböden, 350 mm tief, 450 mm breit, 1247 mm hoch
Bathroom Midi unit, 1 door, 1 drawer, 1 pull-out, 2 shelves, 350 mm deep, 450 mm wide, 1247 mm high

1 × ABD16-38

Abdeckboden, 16 mm stark, 373 mm tief, 453 mm breit
Top shelf, 16 mm thick, 373 mm deep, 453 mm wide

1 × NBWA 100-36

Badezimmer-Waschtischschrank, 1 Innenblende, 1 Auszug, 461 mm tief, 1000 mm breit, 360 mm hoch
Bathroom vanity unit, 1 internal panel, 1 pull-out, 461 mm deep, 1000 mm wide, 360 mm high

1 × 87750

Waschtisch MAX 1010, 487 mm tief, 1010 mm breit, 140 mm hoch
Hand basin MAX 1010, 487 mm deep, 1010 mm wide, 140 mm high

1 × SP-DEV 100

Spiegel DEVA TOUCH mit LED Beleuchtung, 25 mm tief, 1000 mm breit, 720 mm hoch
Mirror DEVA TOUCH with LED lights, 25 mm deep, 1000 mm wide, 720 mm high

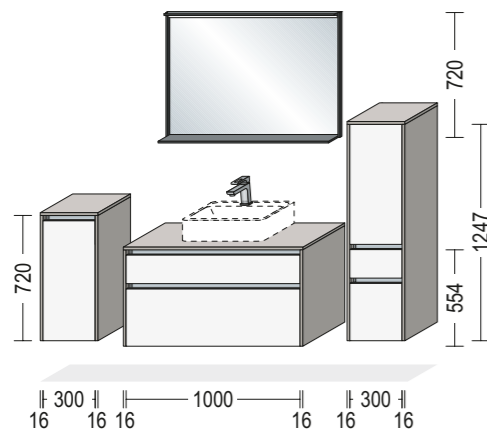

NBSET100-007

1 × NBS 30-72

Badezimmer-Sideboard, 1 Tür, 2 Einlegeböden, 350 mm tief, 300 mm breit, 720 mm hoch
Bathroom sideboard, 1 door, 2 shelves, 350 mm deep, 300 mm wide, 720 mm high

2 × NBSW 16-72

LINE N-Abschlusswangen, 16 mm stark, 371 mm tief, 720 mm hoch
LINE N upright at end of run, 16 mm thick, 371 mm deep, 720 mm high

1 × ADB 16-38

Abdeckboden, 16 mm stark, 373 mm tief, 335 mm breit
Top shelf, 16 mm thick, 373 mm deep, 335 mm wide

1 × NBWSA 100-55

Badezimmer-Waschtischschrank, 1 Schubkasten, 1 Auszug, 461 mm tief, 1000 mm breit, 554 mm hoch
Bathroom vanity unit, 1 drawer, 1 pull-out, 461 mm deep, 1000 mm wide, 554 mm high

2 × NBUW 16-55

LINE N-Abschlusswangen, 16 mm stark, 482 mm tief, 554 mm hoch
LINE N upright at end of run, 16 mm thick, 482 mm deep, 554 mm high

1 × ADB 16-49

Abdeckboden, 16 mm stark, 484 mm tief, 1035 mm breit
Top shelf, 16 mm thick, 484 mm deep, 1035 mm wide

1 × SPLAR 100

Spiegel mit LED-Beleuchtung, 1 Ablagefläche 111 mm tief, 146 mm tief, 1000 mm breit, 720 mm hoch
Mirror with LED lights, 1 shelf 111 mm deep, 146 mm deep, 1000 mm wide, 720 mm high

1 × NBMSA 30-125

Badezimmer-Midischrank, 1 Tür, 1 Schubkasten, 1 Auszug, 2 Einlegeböden, 350 mm tief, 300 mm breit, 1247 mm hoch
Bathroom Midi unit, 1 door, 1 drawer, 1 pull-out, 2 shelves, 350 mm deep, 300 mm wide, 1247 mm high

2 × NBMW 16-125

LINE N-Abschlusswangen, 16 mm stark, 371 mm tief, 1247 mm hoch
LINE N upright at end of run, 16 mm thick, 371 mm deep, 1247 mm high

1 × ADB 16-38

Abdeckboden, 16 mm stark, 373 mm tief, 335 mm breit
Top shelf, 16 mm thick, 373 mm deep, 335 mm wide

Waschtischgröße Hand basin size

1200 mm

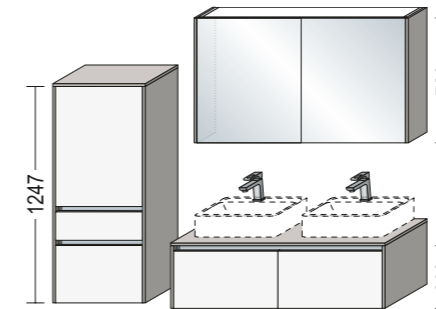

NBSET120-003

1 × NBMSA 50-125

Badezimmer-Midischrank, 1 Tür, 1 Schubkasten, 1 Auszug, 2 Einlegeböden, 350 mm tief, 500 mm breit, 1247 mm hoch
Bathroom Midi unit, 1 door, 1 drawer, 1 pull-out, 2 shelves, 350 mm deep, 500 mm wide, 1247 mm high

2 × NBMW16-125

LINE N-Abschlusswangen, 16 mm stark, 371 mm tief, 1247 mm hoch
LINE N upright at end of run, 16 mm thick, 371 mm deep, 1247 mm high

1 × ADB 16-38

Abdeckboden, 16 mm stark, 373 mm tief, 535 mm breit
Top shelf, 16 mm thick, 373 mm deep, 535 mm wide

2 × NBWA 60-36

Badezimmer-Waschtischschrank, 1 Auszug, 461 mm tief, 600 mm breit, 360 mm hoch
Bathroom vanity unit, 1 pull-out, 461 mm deep, 600 mm wide, 360 mm high

2 × NBUW16-36

LINE N-Abschlusswangen, 16 mm stark, 482 mm tief, 360 mm hoch
LINE N upright at end of run, 16 mm thick, 482 mm deep, 360 mm high

1 × ADB 16-49

Abdeckboden, 16 mm stark, 484 mm tief, 1235 mm breit
Top shelf, 16 mm thick, 484 mm deep, 1235 mm wide

1 × WBSP 120-1

Spiegelschrank, 2 Spiegeltüren, 2 Glaseinlegeböden, 202 mm tief, 1200 mm breit, 720 mm hoch
Mirrored bathroom cabinet, 2 mirrored doors, 2 glass shelves, 202 mm deep, 1200 mm wide, 720 mm high

2 × WWBSP-1

Abschlusswange für Spiegelschrank, 16 mm stark, 213 mm tief, 720 mm hoch
Upright at end of run for mirrored bathroom cabinet, 16 mm thick, 213 mm deep, 720 mm high

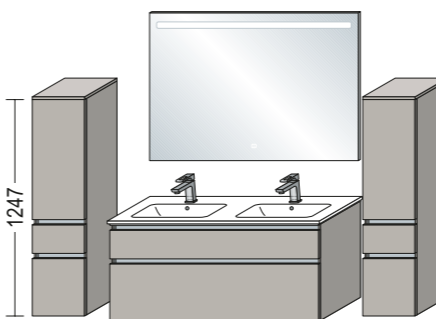

NBSET120-004

1 × NBMSA 30-125

Badezimmer-Midischrank, 1 Tür, 1 Schubkasten, 1 Auszug, 2 Einlegeböden, 350 mm tief, 300 mm breit, 1247 mm hoch
Bathroom Midi unit, 1 door, 1 drawer, 1 pull-out, 2 shelves, 350 mm deep, 300 mm wide, 1247 mm high

1 × ADB 16-38

Abdeckboden, 16 mm stark, 373 mm tief, 303 mm breit
Top shelf, 16 mm thick, 373 mm deep, 303 mm wide

1 × NBWA 120-55

Badezimmer-Waschtischschrank, 1 feste Blende, 1 Auszug, 461 mm tief, 1200 mm breit, 554 mm hoch
Bathroom vanity unit, 1 fixed panel, 1 pull-out, 461 mm deep, 1200 mm wide, 554 mm high

1 × 87722

Doppelwaschtisch MEGX 1200D, 492 mm tief, 1214 mm breit, 142 mm hoch
Double hand basin MEGX 1200D, 492 mm deep, 1214 mm wide, 142 mm high

1 × SPLH 120

Spiegel mit horizontalem LED-Lichtfenster, 24 mm tief, 1200 mm breit, 850 mm hoch
Mirror with horizontal LED light window, 24 mm deep, 1200 mm wide, 850 mm high

1 × NBMSA 30-125

Badezimmer-Midischrank, 1 Tür, 1 Schubkasten, 1 Auszug, 2 Einlegeböden, 350 mm tief, 300 mm breit, 1247 mm hoch
Bathroom Midi unit, 1 door, 1 drawer, 1 pull-out, 2 shelves, 350 mm deep, 300 mm wide, 1247 mm high

1 × ADB 16-38

Abdeckboden, 16 mm stark, 373 mm tief, 303 mm breit
Top shelf, 16 mm thick, 373 mm deep, 303 mm wide

Die Planungsvorschläge enthalten keine Aufsatzwaschtische, Armaturen, Leuchten, Steckdosen oder Ausschnitte in Schubkästen und Abdeckböden. Diese müssen zusätzlich zur Set-Artikelnummer bestellt werden.

The design suggestions do not contain any surface-mounted hand basins, taps, lights, sockets or cut-outs in drawers and top shelves. These must be ordered in addition to the set item number.

Die Planungsvorschläge enthalten keine Aufsatzwaschtische, Armaturen, Leuchten, Steckdosen oder Ausschnitte in Schubkästen und Abdeckböden. Diese müssen zusätzlich zur Set-Artikelnummer bestellt werden.

The design suggestions do not contain any surface-mounted hand basins, taps, lights, sockets or cut-outs in drawers and top shelves. These must be ordered in addition to the set item number.

SPEZIFIKATIONEN SPECIFICATIONS

grifflos handleless

Waschtischgröße Hand basin size

1200 mm

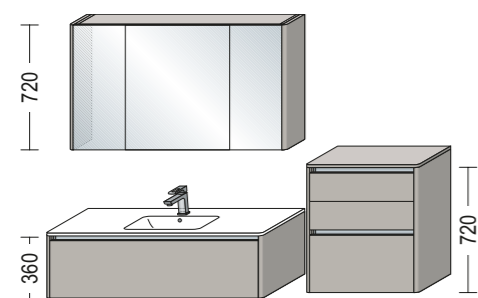

NBSET120-005

1 × NBWA 120-36

Badezimmer-Waschtischschrank, 1 Innenblende, 1 Auszug, 461 mm tief, 1200 mm breit, 360 mm hoch
Bathroom vanity unit, 1 internal panel, 1 pull-out, 461 mm deep, 1200 mm wide, 360 mm high

2 × WAR 25-36

Runde Abschlusswangen, 25 mm stark, 482 mm tief, 360 mm hoch
Round end upright panel, 25 mm thick, 482 mm deep, 360 mm high

1 × 87743

Waschtisch NobX 1260, 487 mm tief, 1260 mm breit, 129 mm hoch
Hand basin NobX 1260, 487 mm deep, 1260 mm wide, 129 mm high

1 × 17715

Geberit Clou Ab- und Überlauf
Geberit Clou drain and overflow

1 × WBSP3 120-1

Spiegelschrank, 3 Spiegeltüren, 4 Glaseinlegeböden, 1 Mittelseite, 202 mm tief, 1200 mm breit, 720 mm hoch
Mirrored bathroom cabinet, 3 mirrored doors, 4 glass shelves, 1 centre panel, 202 mm deep, 1200 mm wide, 720 mm high

2 × WARBSP-1

Runde Abschlusswangen, 25 mm stark, 210 mm tief, 720 mm hoch
Round end upright panel, 25 mm thick, 210 mm deep, 720 mm high

1 × NBS2SA 60-72

Badezimmer-Sideboard, 2 Schubkästen, 1 Auszug, 350 mm tief, 600 mm breit, 720 mm hoch
Bathroom sideboard, 2 drawers, 1 pull-out, 350 mm deep, 600 mm wide, 720 mm high

2 × WAR 25-72

Runde Abschlusswangen, 25 mm stark, 371 mm tief, 720 mm hoch
Round end upright panel, 25 mm thick, 371 mm deep, 720 mm high

1 × ADB 16-38

Abdeckboden, 16 mm stark, 372,5 mm tief, 653 mm breit
Top shelf, 16 mm thick, 372.5 mm deep, 653 mm wide

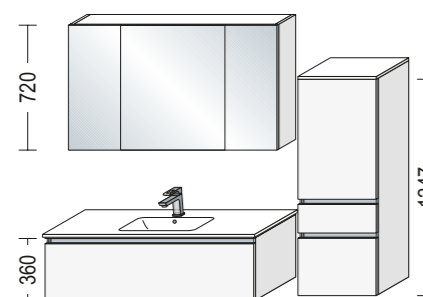
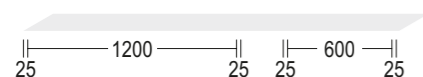

NBSET120-006

1 × NBWA 120-36

Badezimmer-Waschtischschrank, 1 Innenblende, 1 Auszug, 461 mm tief, 1200 mm breit, 360 mm hoch
Bathroom vanity unit, 1 internal panel, 1 pull-out, 461 mm deep, 1200 mm wide, 360 mm high

1 × 87738

Waschtisch LAVABO BLOB 1200, 492 mm tief, 1205 mm breit, 171 mm hoch
Hand basin LAVABO BLOB 1200, 492 mm deep, 1205 mm wide, 171 mm high

1 × WBSP3 120-1

Spiegelschrank, 3 Spiegeltüren, 4 Glaseinlegeböden, 1 Mittelseite, 202 mm tief, 1200 mm breit, 720 mm hoch
Mirrored bathroom cabinet, 3 mirrored doors, 4 glass shelves, 1 centre panel, 202 mm deep, 1200 mm wide, 720 mm high

1 × NBMSA 45-125

Badezimmer-Midischrank, 1 Tür, 1 Schubkasten, 1 Auszug, 2 Einlegeböden, 350 mm tief, 450 mm breit, 1247 mm hoch
Bathroom Midi unit, 1 door, 1 drawer, 1 pull-out, 2 shelves, 350 mm deep, 450 mm wide, 1247 mm high

1 × ADB 16-38

Abdeckboden, 16 mm stark, 373 mm tief, 453 mm breit
Top shelf, 16 mm thick, 373 mm deep, 453 mm wide

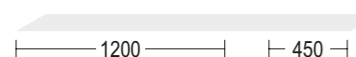

Waschtischgröße Hand basin size

1500 mm

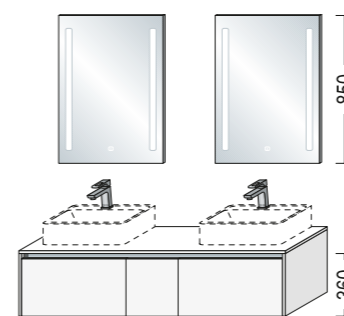

NBSET150-001

1 × NBWA 60-36

Badezimmer-Waschtischschrank, 1 Auszug, 461 mm tief, 600 mm breit, 360 mm hoch
Bathroom vanity unit, 1 pull-out, 461 mm deep, 600 mm wide, 360 mm high

1 × NBUA 30-36

Badezimmer-Unterschrank, 1 Auszug, 461 mm tief, 300 mm breit, 360 mm hoch
Bathroom base unit, 1 pull-out, 461 mm deep, 300 mm wide, 360 mm high

1 × NBWA 60-36

Badezimmer-Waschtischschrank, 1 Auszug, 461 mm tief, 600 mm breit, 360 mm hoch
Bathroom vanity unit, 1 pull-out, 461 mm deep, 600 mm wide, 360 mm high

1 × ADB 16-49

Abdeckboden, 16 mm stark, 484 mm tief, 1535 mm breit
Top shelf, 16 mm thick, 484 mm deep, 1535 mm wide

2 × NBUIW16-36

LINE N-Abschlusswangen, 16 mm stark, 482 mm tief, 360 mm hoch
LINE N upright at end of run, 16 mm thick, 482 mm deep, 360 mm high

2 × SPLY 60

Spiegel mit vertikalen LED-Lichtfenstern, 24 mm tief, 600 mm breit, 850 mm hoch
Mirror with vertical LED light windows, 24 mm deep, 600 mm wide, 850 mm high

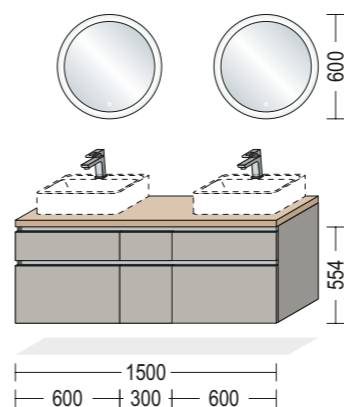
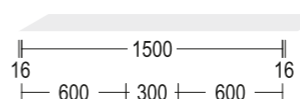

NBSET150-003

1 × NBWSA 60-55

Badezimmer-Waschtischschrank, 1 Schubkasten, 1 Auszug, 461 mm tief, 600 mm breit, 554 mm hoch
Bathroom vanity unit, 1 drawer, 1 pull-out, 461 mm deep, 600 mm wide, 554 mm high

1 × NBUSA 30-55

Badezimmer-Unterschrank, 1 Schubkasten, 1 Auszug, 461 mm tief, 300 mm breit, 554 mm hoch
Bathroom base unit, 1 drawer, 1 pull-out, 461 mm deep, 300 mm wide, 554 mm high

1 × NBWSA 60-55

Badezimmer-Waschtischschrank, 1 Schubkasten, 1 Auszug, 461 mm tief, 600 mm breit, 554 mm hoch
Bathroom vanity unit, 1 drawer, 1 pull-out, 461 mm deep, 600 mm wide, 554 mm high

1 × APD 60

Arbeitsplatte APD mit Dekorkante, 38 mm stark, 484 mm tief, 1503 mm breit
Worktop APD with décor edge, 38 mm thick, 484 mm deep, 1503 mm wide

2 × SP-SOFIA 60

Spiegel SOFIA mit LED Beleuchtung, Durchmesser 600 mm, 25 mm tief
Mirror SOFIA with LED lights, diameter 600 mm, 25 mm deep

Die Planungsvorschläge enthalten keine Aufsatzwaschtische, Armaturen, Leuchten, Steckdosen oder Ausschnitte in Schubkästen und Abdeckböden. Diese müssen zusätzlich zur Set-Artikelnummer bestellt werden.

The design suggestions do not contain any surface-mounted hand basins, taps, lights, sockets or cut-outs in drawers and top shelves. These must be ordered in addition to the set item number.

Die Planungsvorschläge enthalten keine Aufsatzwaschtische, Armaturen, Leuchten, Steckdosen oder Ausschnitte in Schubkästen und Abdeckböden. Diese müssen zusätzlich zur Set-Artikelnummer bestellt werden.

The design suggestions do not contain any surface-mounted hand basins, taps, lights, sockets or cut-outs in drawers and top shelves. These must be ordered in addition to the set item number.

SPEZIFIKATIONEN SPECIFICATIONS

mit Griff with handle

Waschtischgröße Hand basin size
400 / 600 mm

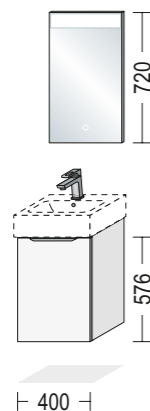

BGSET40-001

mit Gäste-Waschtischschrank, 350 mm tief
with guest vanity unit, 350 mm deep,

1 × BWBG 40-58

Badezimmer-Waschtischschrank, 1 Innenblende, 1 Tür, 1 Einlegeboden,
Bathroom vanity unit, 1 internal panel, 1 door, 1 shelf,
350 mm deep, 400 mm wide, 576 mm high

1 × 87730

Waschtisch CUBO 43, 390 mm tief, 430 mm breit, 182 mm hoch
Hand basin CUBO 43, 390 mm deep, 430 mm wide, 182 mm high

1 × SP-DEV 41

Spiegel DEVA TOUCH mit LED Beleuchtung,
25 mm tief, 410 mm breit, 720 mm hoch
Mirror DEVA TOUCH with LED lights,
25 mm deep, 410 mm wide, 720 mm high

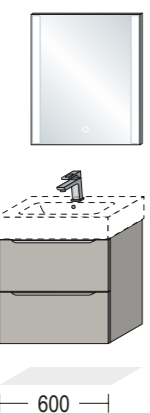

BGSET60-001

mit Gäste-Waschtischschrank, 350 mm tief
with guest vanity unit, 350 mm deep

1 × BWASAG 60-58

Badezimmer-Waschtischschrank, 1 Innenblende, 1 Schubkasten, 1 Auszug,
350 mm tief, 600 mm breit, 576 mm hoch
Bathroom vanity unit, 1 internal panel, 1 drawer, 1 pull-out,
350 mm deep, 600 mm wide, 576 mm high

1 × 87731

Waschtisch CUBO 63, 390 mm tief, 630 mm breit, 120 mm hoch
Hand basin CUBO 63, 390 mm deep, 630 mm wide, 120 mm high

1 × 17713

Geberit Tauchrohrgeruchverschluss
Geberit dip pipe odour trap

1 × SP-EMMA 60

Spiegel EMMA TOUCH mit LED Beleuchtung,
25 mm tief, 600 mm breit, 720 mm hoch
Mirror EMMA TOUCH with LED lights,
25 mm deep, 600 mm wide, 720 mm high

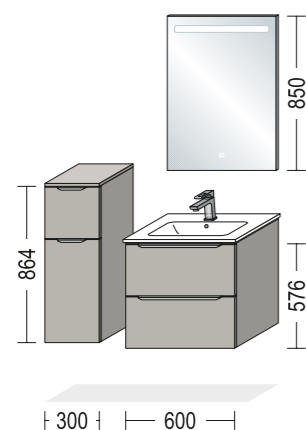

BSET60-001

1 × BSA 30-86

Badezimmer-Sideboard, 1 Auszug, 1 Tür, 1 Einlegeboden,
350 mm tief, 300 mm breit, 864 mm hoch
Bathroom sideboard, 1 pull-out, 1 door, 1 shelf,
350 mm deep, 300 mm wide, 864 mm high

1 × ADB 16-38

Abdeckboden, 16 mm stark, 376 mm tief, 303 mm breit
Top shelf, 16 mm thick, 376 mm deep, 303 mm wide

1 × BWASA 60-58

Badezimmer-Waschtischschrank, 1 Innenblende, 1 Schubkasten, 1 Auszug,
461 mm tief, 600 mm breit, 576 mm hoch
Bathroom vanity unit, 1 internal panel, 1 drawer, 1 pull-out,
461 mm deep, 600 mm wide, 576 mm high

1 × 87706

Waschtisch MEGX 600C, 614 mm breit, 492 mm hoch, 142 mm tief
Hand basin MEGX 600C, 614 mm wide, 492 mm high, 142 mm deep

1 × SPLH 60

Spiegel mit horizontalem LED-Lichtfenster,
24 mm tief, 600 mm breit, 850 mm hoch
Mirror with horizontal LED light window,
24 mm deep, 600 mm wide, 850 mm high

Waschtischgröße Hand basin size
600 mm

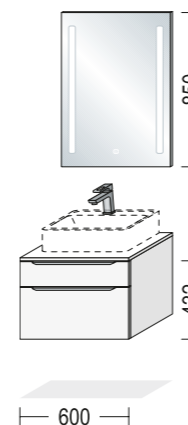

BSET60-002

1 × BWSA 60-43

Badezimmer-Waschtischschrank, 1 Schubkasten, 1 Auszug,
461 mm tief, 600 mm breit, 432 mm hoch
Bathroom vanity unit, 1 drawer, 1 pull-out,
461 mm deep, 600 mm wide, 432 mm high

1 × ADB 16-49

Abdeckboden, 16 mm stark, 487 mm tief, 603 mm breit
Top shelf, 16 mm thick, 487 mm deep, 603 mm wide

1 × SPLV 60

Spiegel mit vertikalen LED-Lichtfenstern,
24 mm tief, 600 mm breit, 850 mm hoch
Mirror with vertical LED light windows,
24 mm deep, 600 mm wide, 850 mm high

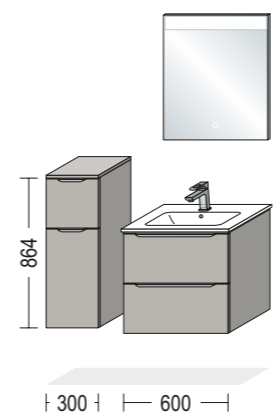

BSET60-004

1 × BSA 30-86

Badezimmer-Sideboard, 1 Auszug, 1 Tür, 1 Einlegeboden
350 mm tief, 300 mm breit, 864 mm hoch
Bathroom sideboard, 1 pull-out, 1 door, 1 shelf,
350 mm deep, 300 mm wide, 864 mm high

1 × ADB 16-38

Abdeckboden, 16 mm stark, 376 mm tief, 303 mm breit
Top shelf, 16 mm thick, 376 mm deep, 303 mm wide

1 × BWASA 60-58

Badezimmer-Waschtischschrank, 1 Innenblende, 1 Schubkasten, 1 Auszug,
461 mm tief, 600 mm breit, 576 mm hoch
Bathroom vanity unit, 1 internal panel, 1 drawer, 1 pull-out,
461 mm deep, 600 mm wide, 576 mm high

1 × 87736

Waschtisch LAVABO BLOB 600
492 mm tief, 605 mm breit, 171 mm hoch
Hand basin LAVABO BLOB 600,
492 mm deep, 605 mm wide, 171 mm high

1 × SP-DEV 60

Spiegel DEVA TOUCH mit LED Beleuchtung
25 mm tief, 600 mm breit, 720 mm hoch
Mirror DEVA TOUCH with LED lights,
25 mm deep, 600 mm wide, 720 mm high

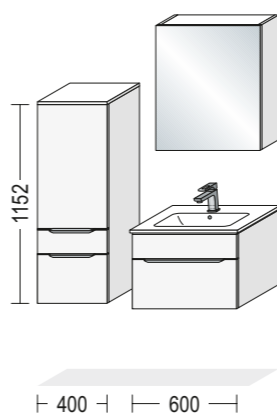

BSET60-005

1 × BMSA 40-115

Badezimmer-Midischrank, 1 Tür, 1 Schubkasten, 1 Auszug, 2 Einlegeböden
350 mm tief, 400 mm breit, 1152 mm hoch
Bathroom Midi unit, 1 door, 1 drawer, 1 pull-out, 2 shelves,
350 mm deep, 400 mm wide, 1152 mm high

1 × ADB 16-38

Abdeckboden, 16 mm stark, 376 mm tief, 403 mm breit
Top shelf, 16 mm thick, 376 mm deep, 403 mm wide

1 × BWA 60-43

Badezimmer-Waschtischschrank, 1 feste Blende, 1 Auszug,
461 mm tief, 600 mm breit, 432 mm hoch
Bathroom vanity unit, 1 fixed panel, 1 pull-out,
461 mm deep, 600 mm wide, 432 mm high

1 × 87746

Waschtisch MAX 610, 487 mm tief, 610 mm breit, 140 mm hoch
Hand basin MAX 610, 487 mm deep, 610 mm wide, 140 mm high

1 × WBSP 60-1

Spiegelschrank, 1 Spiegeltür, 2 Glaseinlegeböden,
202 mm tief, 600 mm breit, 720 mm hoch
Mirrored bathroom cabinet, 1 mirrored door, 2 glass shelves,
202 mm deep, 600 mm wide, 720 mm high

Die Planungsvorschläge enthalten keine Aufsatzwaschtische, Armaturen, Leuchten, Griffleisten-Mehrpreise, Steckdosen oder Ausschnitte in Schubkästen und Abdeckböden. Diese müssen zusätzlich zur Set-Artikelnnummer bestellt werden.

The design suggestions do not contain any surface-mounted hand basins, taps, lights, handle surcharges, sockets or cut-outs in drawers and top shelves. These must be ordered in addition to the set item number.

Die Planungsvorschläge enthalten keine Aufsatzwaschtische, Armaturen, Leuchten, Griffleisten-Mehrpreise, Steckdosen oder Ausschnitte in Schubkästen und Abdeckböden. Diese müssen zusätzlich zur Set-Artikelnnummer bestellt werden.

The design suggestions do not contain any surface-mounted hand basins, taps, lights, handle surcharges, sockets or cut-outs in drawers and top shelves. These must be ordered in addition to the set item number.

SPEZIFIKATIONEN SPECIFICATIONS

mit Griff with handle

Waschtischgröße Hand basin size

800 mm

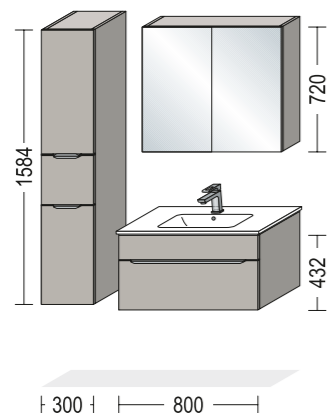

BSET80-002

1 × BMA 30-158

Badezimmer-Midischrank, 1 Tür, 1 Auszug, 1 Tür, 3 Einlegeböden,
350 mm tief, 300 mm breit, 1584 mm hoch
Bathroom Midi unit, 1 door, 1 pull-out, 1 door, 3 shelves,
350 mm deep, 300 mm wide, 1584 mm high

1 × BWA 80-43

Badezimmer-Waschtischschrank, 1 feste Blende, 1 Auszug,
461 mm tief, 800 mm breit, 432 mm hoch
Bathroom vanity unit, 1 fixed panel, 1 pull-out,
461 mm deep, 800 mm wide, 432 mm high

1 × 87708

Waschtisch MEGX 800C, 492 mm tief, 814 mm breit, 142 mm hoch
Hand basin MEGX 800C, 492 mm deep, 814 mm wide, 142 mm high

1 × W BSP 80-1

Spiegelschrank, 2 Spiegeltüren, 2 Glaseinlegeböden,
202 mm tief, 800 mm breit, 720 mm hoch
Mirrored bathroom cabinet, 2 mirrored doors, 2 glass shelves,
202 mm deep, 800 mm wide, 720 mm high

Waschtischgröße Hand basin size

800 mm

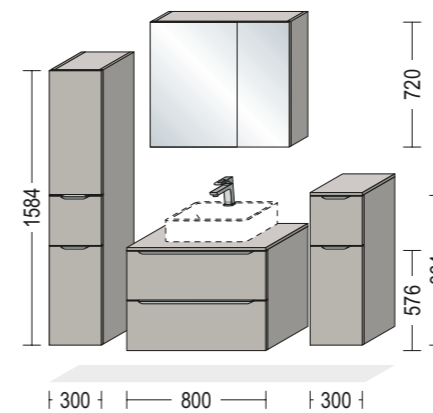

BSET80-007

1 × BMA 30-158

Badezimmer-Midischrank, 1 Tür, 1 Auszug, 1 Tür, 3 Einlegeböden,
350 mm tief, 300 mm breit, 1584 mm hoch
Bathroom Midi unit, 1 door, 1 pull-out, 1 door, 3 shelves,
350 mm deep, 300 mm wide, 1584 mm high

1 × BW2A 80-58

Badezimmer-Waschtischschrank, 2 Auszüge,
461 mm tief, 800 mm breit, 576 mm hoch
Bathroom vanity unit, 2 pull-outs,
461 mm deep, 800 mm wide, 576 mm high

1 × ADB 16-49

Abdeckboden, 16 mm stark, 487 mm tief, 803 mm breit
Top shelf, 16 mm thick, 487 mm deep, 803 mm wide

1 × W BSPA 80-1

Spiegelschrank, 2 Spiegeltüren, 497/297 mm breit, 2 Glaseinlegeböden,
202 mm tief, 800 mm breit, 720 mm hoch
Mirrored bathroom cabinet, 2 mirrored doors, 497/297 mm wide,
2 glass shelves, 202 mm deep, 800 mm wide, 720 mm high

1 × BSA 30-86

Badezimmer-Sideboard, 1 Auszug, 1 Tür, 1 Einlegeboden,
350 mm tief, 300 mm breit, 864 mm hoch
Bathroom sideboard, 1 pull-out, 1 door, 1 shelf,
350 mm deep, 300 mm wide, 864 mm high

1 × ADB 16-38

Abdeckboden, 16 mm stark, 376 mm tief, 303 mm breit
Top shelf, 16 mm thick, 376 mm deep, 303 mm wide

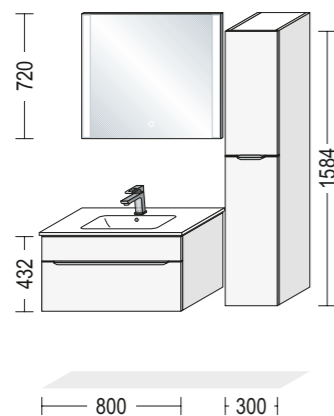

BSET80-006

1 × BWA 80-43

Badezimmer-Waschtischschrank, 1 feste Blende, 1 Auszug,
461 mm tief, 800 mm breit, 432 mm hoch
Bathroom vanity unit, 1 fixed panel, 1 pull-out,
461 mm deep, 800 mm wide, 432 mm high

1 × 87748

Waschtisch MAX 810, 487 mm tief, 810 mm breit, 140 mm hoch
Hand basin MAX 810, 487 mm deep, 810 mm wide, 140 mm high

1 × SP-EMMA 80

Spiegel EMMA TOUCH mit LED Beleuchtung,
25 mm tief, 800 mm breit, 720 mm hoch
Mirror EMMA TOUCH with LED lights,
25 mm deep, 800 mm wide, 720 mm high

1 × BM 30-158

Badezimmer-Midischrank, 2 Türen, 4 Einlegeböden,
350 mm tief, 300 mm breit, 1584 mm hoch
Bathroom Midi unit, 2 doors, 4 shelves,
350 mm deep, 300 mm wide, 1584 mm high

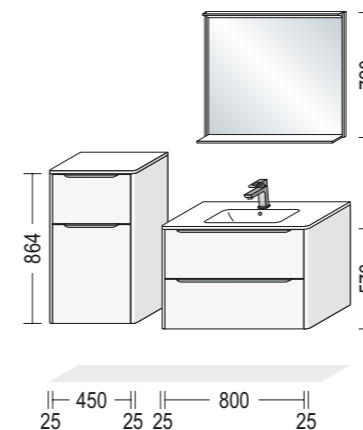

BSET80-008

1 × BSA 45-86

Badezimmer-Sideboard, 1 Auszug, 1 Tür, 1 Einlegeboden,
350 mm tief, 450 mm breit, 864 mm hoch
Bathroom sideboard, 1 pull-out, 1 door, 1 shelf,
350 mm deep, 450 mm wide, 864 mm high

2 × WAR 25-86

Runde Abschlusswangen, 25 mm stark, 371 mm tief, 864 mm hoch
Round end upright panel, 25 mm thick, 371 mm deep, 864 mm high

1 × ADB 16-38

Abdeckboden, 16 mm stark, 372,5 mm tief, 503 mm breit
Top shelf, 16 mm thick, 372.5 mm deep, 503 mm wide

1 × BWASA 80-58

Badezimmer-Waschtischschrank, 1 Innenblende, 1 Schubkasten, 1 Auszug,
461 mm tief, 800 mm breit, 576 mm hoch
Bathroom vanity unit, 1 internal panel, 1 drawer, 1 pull-out,
461 mm deep, 800 mm wide, 576 mm high

2 × WAR 25-58

Runde Abschlusswangen, 25 mm stark, 482 mm tief, 576 mm hoch
Round end upright panel, 25 mm thick, 482 mm deep, 576 mm high

1 × 87741

Waschtisch NobX 860, 487 mm tief, 860 mm breit, 129 mm hoch
Hand basin NobX 860, 487 mm deep, 860 mm wide, 129 mm high

1 × 17715

Geberit Clou Ab- und Überlauf
Geberit Clou drain and overflow

1 × SPLAR 80

Spiegel mit LED-Beleuchtung, 1 Ablagefläche 111 mm tief,
146 mm tief, 800 mm breit, 720 mm hoch
Mirror with LED lights, 1 shelf 111 mm deep,
146 mm deep, 800 mm wide, 720 mm high

Die Planungsvorschläge enthalten keine Aufsatzwaschtische, Armaturen, Leuchten, Griffleisten-Mehrpreise, Steckdosen oder Ausschnitte in Schubkästen und Abdeckböden. Diese müssen zusätzlich zur Set-Artikelnummer bestellt werden.

The design suggestions do not contain any surface-mounted hand basins, taps, lights, handle surcharges, sockets or cut-outs in drawers and top shelves. These must be ordered in addition to the set item number.

Die Planungsvorschläge enthalten keine Aufsatzwaschtische, Armaturen, Leuchten, Griffleisten-Mehrpreise, Steckdosen oder Ausschnitte in Schubkästen und Abdeckböden. Diese müssen zusätzlich zur Set-Artikelnummer bestellt werden.

The design suggestions do not contain any surface-mounted hand basins, taps, lights, handle surcharges, sockets or cut-outs in drawers and top shelves. These must be ordered in addition to the set item number.

SPEZIFIKATIONEN SPECIFICATIONS

mit Griff with handle

Waschtischgröße Hand basin size

900 mm

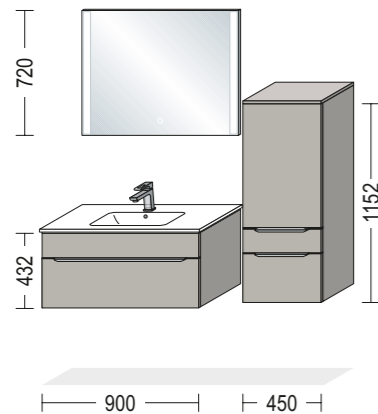

BSET90-001

1 × BWA 90-43

Badezimmer-Waschtischschrank, 1 feste Blende, 1 Auszug,
461 mm tief, 900 mm breit, 432 mm hoch
Bathroom vanity unit, 1 fixed panel, 1 pull-out,
461 mm deep, 900 mm wide, 432 mm high

1 × 87737

Waschtisch LAVABO BLOB 900,
492 mm tief, 905 mm breit, 171 mm hoch
Hand basin LAVABO BLOB 900,
492 mm deep, 905 mm wide, 171 mm high

1 × SP-EMMA 90

Spiegel EMMA TOUCH mit LED Beleuchtung,
25 mm tief, 900 mm breit, 720 mm hoch
Mirror EMMA TOUCH with LED lights,
25 mm deep, 900 mm wide, 720 mm high

1 × BMSA 45-115

Badezimmer-Midischrank, 1 Tür, 1 Schubkasten, 1 Auszug,
2 Einlegeböden, 350 mm tief, 450 mm breit, 1152 mm hoch
Bathroom Midi unit, 1 door, 1 drawer, 1 pull-out, 2 shelves,
350 mm deep, 450 mm wide, 1152 mm high

1 × ADB 16-38

Abdeckboden, 16 mm stark, 376 mm tief, 453 mm breit
Top shelf, 16 mm thick, 376 mm deep, 453 mm wide

Waschtischgröße Hand basin size

1000 mm

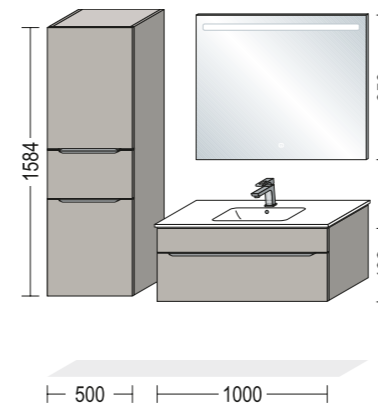

BSET100-001

1 × BMA 50-158

Badezimmer-Midischrank, 1 Tür, 1 Auszug, 1 Tür, 3 Einlegeböden,
350 mm tief, 500 mm breit, 1584 mm hoch
Bathroom Midi unit, 1 door, 1 pull-out, 1 door, 3 shelves,
350 mm deep, 500 mm wide, 1584 mm high

1 × BWA 100-43

Badezimmer-Waschtischschrank, 1 feste Blende, 1 Auszug,
461 mm tief, 1000 mm breit, 432 mm hoch
Bathroom vanity unit, 1 fixed panel, 1 pull-out,
461 mm deep, 1000 mm wide, 432 mm high

1 × 87710

Waschtisch MEGX 1000C, 492 mm tief, 1014 mm breit, 142 mm hoch
Hand basin MEGX 1000C, 492 mm deep, 1014 mm wide, 142 mm high

1 × SPLH 100

Spiegel mit horizontalem LED-Lichtfenster,
24 mm tief, 1000 mm breit, 850 mm hoch
Mirror with horizontal LED light window,
24 mm deep, 1000 mm wide, 850 mm high

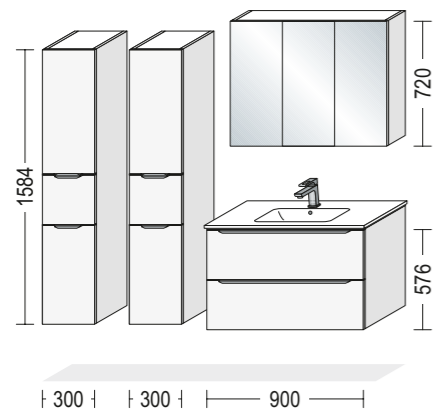

BSET90-002

2 × BMA 30-158

Badezimmer-Midischrank, 1 Tür, 1 Auszug, 1 Tür, 3 Einlegeböden,
350 mm tief, 300 mm breit, 1584 mm hoch
Bathroom Midi unit, 1 door, 1 pull-out, 1 door, 3 shelves,
350 mm deep, 300 mm wide, 1584 mm high

1 × BWASA 90-58

Badezimmer-Waschtischschrank, 1 Innenblende, 1 Schubkasten, 1 Auszug,
461 mm tief, 900 mm breit, 576 mm hoch
Bathroom vanity unit, 1 internal panel, 1 drawer, 1 pull-out,
461 mm deep, 900 mm wide, 576 mm high

1 × 87737

Waschtisch LAVABO BLOB 900,
492 mm tief, 905 mm breit, 171 mm hoch
Hand basin LAVABO BLOB 900,
492 mm deep, 905 mm wide, 171 mm high

1 × WBSP3 90-1

Spiegelschrank, 3 Spiegeltüren, 4 Glaseinlegeböden, 1 Mittelseite,
202 mm tief, 900 mm breit, 720 mm hoch
Mirrored bathroom cabinet, 3 mirrored doors, 4 glass shelves,
1 centre panel, 202 mm deep, 900 mm wide, 720 mm high

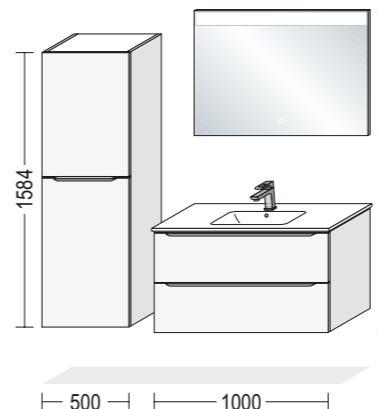

BSET100-004

1 × BM 50-158

Badezimmer-Midischrank, 2 Türen, 4 Einlegeböden,
350 mm tief, 500 mm breit, 1584 mm hoch
Bathroom Midi unit, 2 doors, 4 shelves,
350 mm deep, 500 mm wide, 1584 mm high

1 × BWASA 100-58

Badezimmer-Waschtischschrank, 1 Innenblende, 1 Schubkasten,
1 Auszug, 461 mm tief, 1000 mm breit, 576 mm hoch
Bathroom vanity unit, 1 internal panel, 1 drawer, 1 pull-out,
461 mm deep, 1000 mm wide, 576 mm high

1 × 87750

Waschtisch MAX 1010, 487 mm tief, 1010 mm breit, 140 mm hoch
Hand basin MAX 1010, 487 mm deep, 1010 mm wide, 140 mm high

1 × SP-DEV 100

Spiegel DEVA TOUCH mit LED Beleuchtung,
25 mm tief, 1000 mm breit, 720 mm hoch
Mirror DEVA TOUCH with LED lights,
25 mm deep, 1000 mm wide, 720 mm high

Die Planungsvorschläge enthalten keine Aufsatzwaschtische, Armaturen, Leuchten, Griffleisten-Mehrpreise, Steckdosen oder Ausschnitte in Schubkästen und Abdeckböden. Diese müssen zusätzlich zur Set-Artikelnummer bestellt werden.

The design suggestions do not contain any surface-mounted hand basins, taps, lights, handle surcharges, sockets or cut-outs in drawers and top shelves. These must be ordered in addition to the set item number.

Die Planungsvorschläge enthalten keine Aufsatzwaschtische, Armaturen, Leuchten, Griffleisten-Mehrpreise, Steckdosen oder Ausschnitte in Schubkästen und Abdeckböden. Diese müssen zusätzlich zur Set-Artikelnummer bestellt werden.

The design suggestions do not contain any surface-mounted hand basins, taps, lights, handle surcharges, sockets or cut-outs in drawers and top shelves. These must be ordered in addition to the set item number.

SPEZIFIKATIONEN SPECIFICATIONS

mit Griff with handle

Waschtischgröße Hand basin size

1000 mm

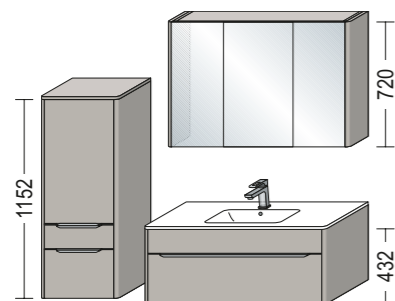

BSET100-005

1 × BMSA 40-115

Badezimmer-Midischrank, 1 Tür, 1 Schubkasten, 1 Auszug, 2 Einlegeböden,
350 mm tief, 400 mm breit, 1152 mm hoch
Bathroom Midi unit, 1 door, 1 drawer, 1 pull-out, 2 shelves,
350 mm deep, 400 mm wide, 1152 mm high

2 × WAR 25-115

Runde Abschlusswangen, 25 mm stark, 371 mm tief, 1152 mm hoch
Round end upright panel, 25 mm thick, 371 mm deep, 1152 mm high

1 × ADB 16-38

Abdeckboden, 16 mm stark, 372,5 mm tief, 453 mm breit
Top shelf, 16 mm thick, 372.5 mm deep, 453 mm wide

1 × BWA 100-43

Badezimmer-Waschtischschrank, 1 feste Blende, 1 Auszug,
461 mm tief, 1000 mm breit, 432 mm hoch
Bathroom vanity unit, 1 fixed panel, 1 pull-out,
461 mm deep, 1000 mm wide, 432 mm high

2 × WAR 25-43

Runde Abschlusswangen, 25 mm stark, 482 mm tief, 432 mm hoch
Round end upright panel, 25 mm thick, 482 mm deep, 432 mm high

1 × 87742

Waschtisch NobX 1060, 487 mm tief, 1060 mm breit, 129 mm hoch
Hand basin NobX 1060, 487 mm deep, 1060 mm wide, 129 mm high

1 × 17715

Geberit Clou Ab- und Überlauf
Geberit Clou drain and overflow

1 × WBSP3 100-1

Spiegelschrank, 3 Spiegeltüren, 4 Glaseinlegeböden, 1 Mittelseite,
202 mm tief, 1000 mm breit, 720 mm hoch
Mirrored bathroom cabinet, 3 mirrored doors, 4 glass shelves,
1 centre panel, 202 mm deep, 1000 mm wide, 720 mm high

2 × WARBSP-1

Runde Abschlusswangen, 25 mm stark, 210 mm tief, 720 mm hoch
Round end upright panel, 25 mm thick, 210 mm deep, 720 mm high

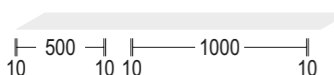
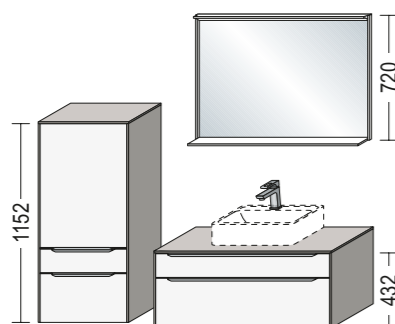

BSET100-006

1 × BMSA 50-115

Badezimmer-Midischrank, 1 Tür, 1 Schubkasten, 1 Auszug,
2 Einlegeböden, 350 mm tief, 500 mm breit, 1152 mm hoch
Bathroom Midi unit, 1 door, 1 drawer, 1 pull-out, 2 shelves,
350 mm deep, 500 mm wide, 1152 mm high

2 × BMW 10-115

Abschlusswangen, 10 mm stark, 371 mm tief, 1152 mm hoch
Upright at end of run, 10 mm thick, 371 mm deep, 1152 mm high

1 × ADB 10-38

Abdeckboden, 10 mm stark, 376 mm tief, 523 mm breit
Top shelf, 10 mm thick, 376 mm deep, 523 mm wide

1 × BWSA 100-43

Badezimmer-Waschtischschrank, 1 Schubkasten, 1 Auszug,
461 mm tief, 1000 mm breit, 432 mm hoch
Bathroom vanity unit, 1 drawer, 1 pull-out,
461 mm deep, 1000 mm wide, 432 mm high

2 × BUW 10-43

Abschlusswangen, 10 mm stark, 485 mm tief, 432 mm hoch
Upright at end of run, 10 mm thick, 485 mm deep, 432 mm high

1 × ADB 16-49

Abdeckboden, 16 mm stark, 487 mm tief, 1023 mm breit
Top shelf, 16 mm thick, 487 mm deep, 1023 mm wide

1 × SPLAR 100

Spiegel mit LED-Beleuchtung, 1 Ablagefläche 111 mm tief,
146 mm tief, 1000 mm breit, 720 mm hoch
Mirror with LED lights, 1 shelf 111 mm deep,
146 mm deep, 1000 mm wide, 720 mm high

Die Planungsvorschläge enthalten keine Aufsatzwaschtische, Armaturen, Leuchten, Griffleisten-Mehrpreise, Steckdosen oder Ausschnitte in Schubkästen und Abdeckböden. Diese müssen zusätzlich zur Set-Artikelnummer bestellt werden.

The design suggestions do not contain any surface-mounted hand basins, taps, lights, handle surcharges, sockets or cut-outs in drawers and top shelves. These must be ordered in addition to the set item number.

Waschtischgröße Hand basin size

1200 mm

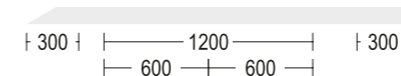
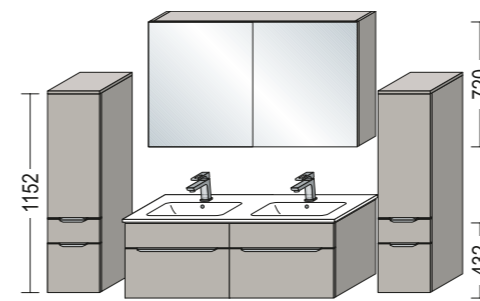

BSET120-003

1 × BMSA 30-115

Badezimmer-Midischrank, 1 Tür, 1 Schubkasten, 1 Auszug,
2 Einlegeböden, 350 mm tief, 300 mm breit, 1152 mm hoch
Bathroom Midi unit, 1 door, 1 drawer, 1 pull-out, 2 shelves,
350 mm deep, 300 mm wide, 1152 mm high

2 × BWA 60-43

Badezimmer-Waschtischschrank, 1 feste Blende, 1 Auszug
461 mm tief, 600 mm breit, 432 mm hoch
Bathroom vanity unit, 1 fixed panel, 1 pull-out,
461 mm deep, 600 mm wide, 432 mm high

1 × 87722

Doppelwaschtisch MEGX 1200D,
492 mm tief, 1214 mm breit, 142 mm hoch
Double hand basin MEGX 1200D,
492 mm deep, 1214 mm wide, 142 mm high

1 × WBSP 120-1

Spiegelschrank, 2 Spiegeltüren, 2 Glaseinlegeböden
202 mm tief, 1200 mm breit, 720 mm hoch
Mirrored bathroom cabinet, 2 mirrored doors, 2 glass shelves,
202 mm deep, 1200 mm wide, 720 mm high

1 × BMSA 30-115

Badezimmer-Midischrank, 1 Tür, 1 Schubkasten, 1 Auszug,
2 Einlegeböden, 350 mm tief, 300 mm breit, 1152 mm hoch
Bathroom Midi unit, 1 door, 1 drawer, 1 pull-out, 2 shelves,
350 mm deep, 300 mm wide, 1152 mm high

2 × ADB 16-38

Abdeckboden, 16 mm stark, 376 mm tief, 303 mm breit
Top shelf, 16 mm thick, 376 mm deep, 303 mm wide

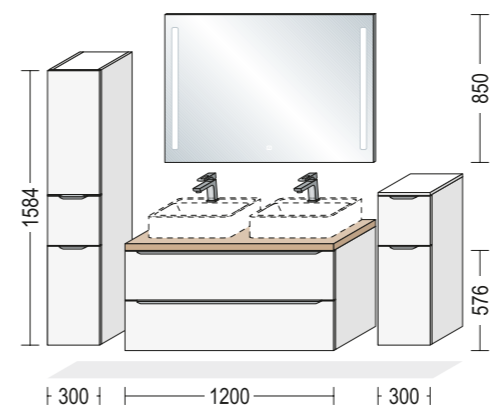

BSET120-004

1 × BMA 30-158

Badezimmer-Midischrank, 1 Tür, 1 Auszug, 1 Tür, 3 Einlegeböden
350 mm tief, 300 mm breit, 1584 mm hoch
Bathroom Midi unit, 1 door, 1 pull-out, 1 door, 3 shelves,
350 mm deep, 300 mm wide, 1584 mm high

1 × BW2A 120-58

Badezimmer-Waschtischschrank, 2 Auszüge,
461 mm tief, 1200 mm breit, 576 mm hoch
Bathroom vanity unit, 2 pull-outs,
461 mm deep, 1200 mm wide, 576 mm high

1 × APD 60

Arbeitsplatte APD mit Dekorkante,
38 mm stark, 487 mm tief, 1203 mm breit
Worktop APD with décor edge,
38 mm thick, 487 mm deep, 1203 mm wide

1 × SPLV 120

Spiegel mit vertikalen LED-Lichtfenstern,
24 mm tief, 1200 mm breit, 850 mm hoch
Mirror with vertical LED light windows,
24 mm deep, 1200 mm wide, 850 mm high

1 × BSA 30-86

Badezimmer-Sideboard, 1 Auszug, 1 Tür, 1 Einlegeboden
350 mm tief, 300 mm breit, 864 mm hoch
Bathroom sideboard, 1 pull-out, 1 door, 1 shelf,
350 mm deep, 300 mm wide, 864 mm high

1 × ADB 16-38

Abdeckboden, 16 mm stark, 376 mm tief, 303 mm breit
Top shelf, 16 mm thick, 376 mm deep, 303 mm wide

Die Planungsvorschläge enthalten keine Aufsatzwaschtische, Armaturen, Leuchten, Griffleisten-Mehrpreise, Steckdosen oder Ausschnitte in Schubkästen und Abdeckböden. Diese müssen zusätzlich zur Set-Artikelnummer bestellt werden.

The design suggestions do not contain any surface-mounted hand basins, taps, lights, handle surcharges, sockets or cut-outs in drawers and top shelves. These must be ordered in addition to the set item number.

SPEZIFIKATIONEN SPECIFICATIONS

mit Griff with handle

Waschtischgröße Hand basin size
1200 mm

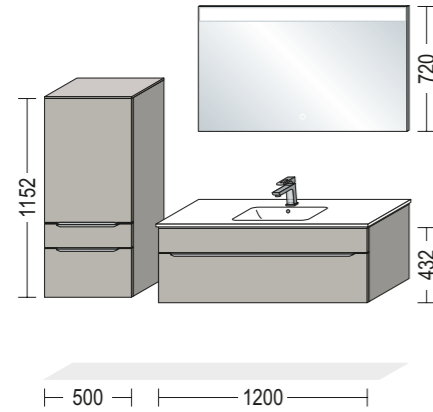

BSET120-005

1 × BMSA 50-115

Badezimmer-Midischrank, 1 Tür, 1 Schubkasten, 1 Auszug, 2 Einlegeböden, 350 mm tief, 500 mm breit, 1152 mm hoch
Bathroom Midi unit, 1 door, 1 drawer, 1 pull-out, 2 shelves, 350 mm deep, 500 mm wide, 1152 mm high

1 × ADB 16-38

Abdeckboden, 16 mm stark, 376 mm tief, 503 mm breit
Top shelf, 16 mm thick, 376 mm deep, 503 mm wide

1 × BWA 120-43

Badezimmer-Waschtischschrank, 1 feste Blende, 1 Auszug, 461 mm tief, 1200 mm breit, 432 mm hoch
Bathroom vanity unit, 1 fixed panel, 1 pull-out, 461 mm deep, 1200 mm wide, 432 mm high

1 × 87751

Waschtisch MAX 1210, 487 mm tief, 1210 mm breit, 140 mm hoch
Hand basin MAX 1210, 487 mm deep, 1210 mm wide, 140 mm high

1 × SP-DEV 120

Spiegel DEVA TOUCH mit LED Beleuchtung, 25 mm tief, 1200 mm breit, 720 mm hoch
Mirror DEVA TOUCH with LED lights, 25 mm deep, 1200 mm wide, 720 mm high

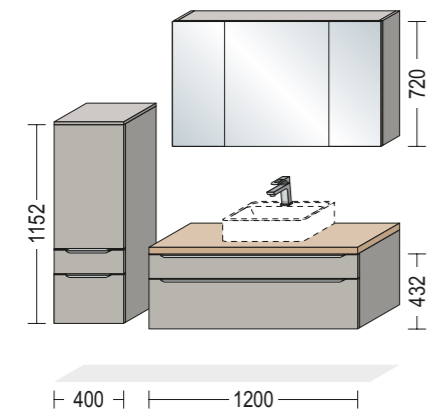

BSET120-006

1 × BMSA 40-115

Badezimmer-Midischrank, 1 Tür, 1 Schubkasten, 1 Auszug, 2 Einlegeböden, 350 mm tief, 400 mm breit, 1152 mm hoch
Bathroom Midi unit, 1 door, 1 drawer, 1 pull-out, 2 shelves, 350 mm deep, 400 mm wide, 1152 mm high

1 × ADB 16-38

Abdeckboden, 16 mm stark, 376 mm tief, 403 mm breit
Top shelf, 16 mm thick, 376 mm deep, 403 mm wide

1 × BWSA 120-43

Badezimmer-Waschtischschrank, 1 Schubkasten, 1 Auszug, 461 mm tief, 1200 mm breit, 432 mm hoch
Bathroom vanity unit, 1 drawer, 1 pull-out, 461 mm deep, 1200 mm wide, 432 mm high

1 × APD 60

Arbeitsplatte APD mit Dekorkante, 38 mm stark, 487 mm tief, 1203 mm breit
Worktop APD with décor edge, 38 mm thick, 487 mm deep, 1203 mm wide

1 × WBS P3 120-1

Spiegelschrank, 3 Spiegeltüren, 4 Glaseinlegeböden, 1 Mittelseite, 202 mm tief, 1200 mm breit, 720 mm hoch
Mirrored bathroom cabinet, 3 mirrored doors, 4 glass shelves, 1 centre panel, 202 mm deep, 1200 mm wide, 720 mm high

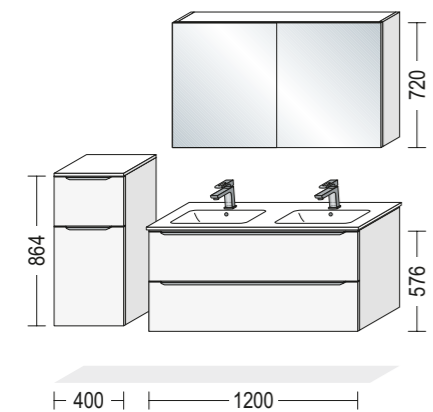

BSET120-007

1 × BSA 40-86

Badezimmer-Sideboard, 1 Auszug, 1 Tür, 1 Einlegeboden, 350 mm tief, 400 mm breit, 864 mm hoch
Bathroom sideboard, 1 pull-out, 1 door, 1 shelf, 350 mm deep, 400 mm wide, 864 mm high

1 × ADB 16-38

Abdeckboden, 16 mm stark, 376 mm tief, 403 mm breit
Top shelf, 16 mm thick, 376 mm deep, 403 mm wide

1 × BWASA 120-58

Badezimmer-Waschtischschrank, 1 Innenblende, 1 Schubkasten, 1 Auszug, 461 mm tief, 1200 mm breit, 576 mm hoch
Bathroom vanity unit, 1 internal panel, 1 drawer, 1 pull-out, 461 mm deep, 1200 mm wide, 576 mm high

1 × 87739

Doppelwaschtisch LAVABO BLOB 1200 2 V, 492 mm tief, 1205 mm breit, 171 mm hoch
Double hand basin LAVABO BLOB 1200 2 V, 492 mm deep, 1205 mm wide, 171 mm high

1 × WBS P 120-1

Spiegelschrank, 2 Spiegeltüren, 2 Glaseinlegeböden, 202 mm tief, 1200 mm breit, 720 mm hoch
Mirrored bathroom cabinet, 2 mirrored doors, 2 glass shelves, 202 mm deep, 1200 mm wide, 720 mm high

Die Planungsvorschläge enthalten keine Aufsatzwaschtische, Armaturen, Leuchten, Griffleisten-Mehrpreise, Steckdosen oder Ausschnitte in Schubkästen und Abdeckböden. Diese müssen zusätzlich zur Set-Artikelnnummer bestellt werden.

The design suggestions do not contain any surface-mounted hand basins, taps, lights, handle surcharges, sockets or cut-outs in drawers and top shelves. These must be ordered in addition to the set item number.

Waschtischgröße Hand basin size
1500 mm

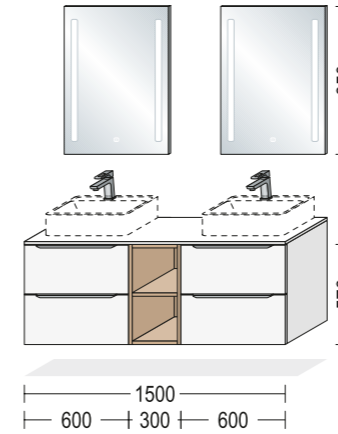

BSET150-002

1 × BW2A 60-58

Badezimmer-Waschtischschrank, 2 Auszüge, 461 mm tief, 600 mm breit, 576 mm hoch
Bathroom vanity unit, 2 pull-outs, 461 mm deep, 600 mm wide, 576 mm high

1 × BUR 30-58

Badezimmer-Unterschrankregal, 1 fester Boden, 482 mm tief, 300 mm breit, 576 mm hoch
Bathroom open shelf base unit, 1 fixed shelf, 482 mm deep, 300 mm wide, 576 mm high

1 × BW2A 60-58

Badezimmer-Waschtischschrank, 2 Auszüge, 461 mm tief, 600 mm breit, 576 mm hoch
Bathroom vanity unit, 2 pull-outs, 461 mm deep, 600 mm wide, 576 mm high

1 × ADB 16-49

Abdeckboden, 16 mm stark, 487 mm tief, 1503 mm breit
Top shelf, 16 mm thick, 487 mm deep, 1503 mm wide

2 × SPLV 60

Spiegel mit vertikalen LED-Lichtfenstern, 24 mm tief, 600 mm breit, 850 mm hoch
Mirror with vertical LED light windows, 24 mm deep, 600 mm wide, 850 mm high

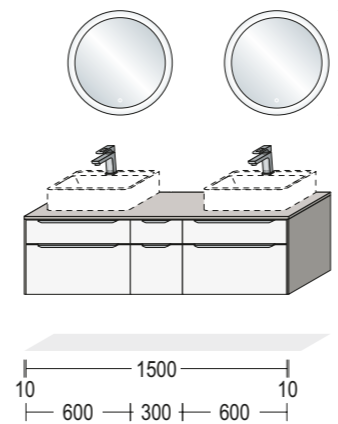

BSET150-003

1 × BWSA 60-43

Badezimmer-Waschtischschrank, 1 Schubkasten, 1 Auszug, 461 mm tief, 600 mm breit, 432 mm hoch
Bathroom vanity unit, 1 drawer, 1 pull-out, 461 mm deep, 600 mm wide, 432 mm high

1 × BUSA 30-43

Badezimmer-Unterschrank, 1 Schubkasten, 1 Auszug, 461 mm tief, 300 mm breit, 432 mm hoch
Bathroom base unit, 1 drawer, 1 pull-out, 461 mm deep, 300 mm wide, 432 mm high

1 × BWSA 60-43

Badezimmer-Waschtischschrank, 1 Schubkasten, 1 Auszug, 461 mm tief, 600 mm breit, 432 mm hoch
Bathroom vanity unit, 1 drawer, 1 pull-out, 461 mm deep, 600 mm wide, 432 mm high

2 × BUW 10-43

Abschlusswangen, 10 mm stark, 485 mm tief, 432 mm hoch
Upright at end of run, 10 mm thick, 485 mm deep, 432 mm high

1 × ADB 16-49

Abdeckboden, 16 mm stark, 487 mm tief, 1523 mm breit
Top shelf, 16 mm thick, 487 mm deep, 1523 mm wide

2 × SP-SOFIA 60

Spiegel SOFIA mit LED Beleuchtung, Durchmesser 600 mm, 25 mm tief
Mirror SOFIA with LED lights, diameter 600 mm, 25 mm deep

Die Planungsvorschläge enthalten keine Aufsatzwaschtische, Armaturen, Leuchten, Griffleisten-Mehrpreise, Steckdosen oder Ausschnitte in Schubkästen und Abdeckböden. Diese müssen zusätzlich zur Set-Artikelnnummer bestellt werden.

The design suggestions do not contain any surface-mounted hand basins, taps, lights, handle surcharges, sockets or cut-outs in drawers and top shelves. These must be ordered in addition to the set item number.

DETAILS INNENAUSSTATTUNG UND ZUBEHÖR*

DETAILS OF INTERIOR FITTINGS AND ACCESSORIES*



Spiegelschrank 2-türig
Mirrored cabinet 2 doors



Spiegelschrank 3-türig
Mirrored cabinet 3 doors



Beleuchtete Griffmulde LINE N
Lighted recessed handle LINE N



LED-Waschtischleuchte für Waschtisch Marmite
LED hand basin lighting strip for Marmite hand basin



LED-Aufsatzleuchte Lilium Big Emotion
LED surface-mounted lights Lilium Big Emotion



LED-Aufsatzleuchte
LED surface-mounted lights



Siphon-Aussparung
Siphon cut-out



3-teiliges Utensilien-System zur Abdeckung der Siphon-Aussparung
3-part utensil system to cover the siphon cut-out



Spiegelschrank mit beleuchteten Wangen
Mirrored cabinet with illuminated upright panels



Spiegelschrank mit Doppelsteckdose
Mirrored cabinet with double socket



Badezimmer-Midischrank Laundry-Carrier
Bathroom midi unit Laundry Carrier



Einbau-Abfallsammler Separato
Built-in waste collector Separato

DETAILS INNENAUSSTATTUNG UND ZUBEHÖR* DETAILS OF INTERIOR FITTINGS AND ACCESSORIES*



Handtuchhalter zur Planung auf 16 mm starken Wänden
Towel rail for planning on 16 mm thick upright panels



Wandkonsole aus Stahl, lieferbar in Schwarz und Chrom Glanz
Wall bracket in steel, available in black and chrome gloss



Handtuchhalterkufe aus Stahl, lieferbar in Schwarz und Chrom Glanz
Rail for towel rail in steel, available in black and chrome gloss



Sockelkufen aus Stahl, lieferbar in Schwarz und Chrom Glanz
Plinth leg in steel, available in black and chrome gloss



Sockelfüße aus Stahl, lieferbar in Schwarz und Chrom Glanz
Plinth foot in steel, available in black and chrome gloss



Universalablage und Hakenleiste LINERO-MosaiQ
Universal shelf and hook strip LINERO-MosaiQ

FRONTEN FRONTS

Fronten, die mit dem LINE N-Logo versehen sind, sind auch als grifflose Planungen lieferbar.
Fronts marked with the LINE N logo are also available as handleless designs.

	SPEED 244 Alpinweiß	PG 1		SPEED 239 Weiß softmatt	PG 1		SPEED 206 Magnolia softmatt	PG 1		SPEED 259 Seidengrau	PG 1		SPEED 288 Schwarzbeton Nachbildung	PG 1		SPEED 262 Eiche Virginia Nachbildung	PG 1
	SPEED 244 Alpine white	PG 1		SPEED 239 White softmatt	PG 1		SPEED 206 Ivory softmatt	PG 1		SPEED 259 Satin grey	PG 1		SPEED 288 Black Concrete reproduction	PG 1		SPEED 262 Virginia oak reproduction	PG 1
	LASER 427 Alpinweiß	PG 2		LASER 416 Weiß	PG 2		LASER 418 Magnolia matt	PG 2		LASER 417 Seidengrau	PG 2		LASER 415 Sand	PG 2		RIVA 891 Weißbeton Nachbildung	PG 2
	LASER 427 Alpine white	PG 2		LASER 416 White	PG 2		LASER 418 Ivory matt	PG 2		LASER 417 Satin grey	PG 2		LASER 415 Sand	PG 2		RIVA 891 White Concrete reproduction	PG 2
	RIVA 892 Beton grau Nachbildung	PG 2		RIVA 889 Beton schiefergrau Nachbildung	PG 2		RIVA 839 Beton Terragrau Nachbildung	PG 2		RIVA 893 Eiche San Remo Nachbildung	PG 2		RIVA 887 Eiche Somerset Nachbildung	PG 2		RIVA 840 Nussbaum Nachbildung	PG 2
	RIVA 892 Concrete grey reproduction	PG 2		RIVA 889 Concrete Slate Grey reproduction	PG 2		RIVA 839 Concrete Terra grey reproduction	PG 2		RIVA 893 Sanremo oak reproduction	PG 2		RIVA 887 Somerset oak reproduction	PG 2		RIVA 840 Walnut reproduction	PG 2
	STRUCTURA 401 Eiche Halifax Nachbildung	PG 3		STRUCTURA 402 Eiche Havanna Nachbildung	PG 3		STRUCTURA 405 Eiche Sierra Nachbildung	PG 3		STRUCTURA 403 Eiche Nero Nachbildung	PG 3		TOUCH 332 Lacklaminat, Alpinweiß supermatt	PG 3		TOUCH 336 Lacklaminat, Magnolia supermatt	PG 3
	STRUCTURA 401 Sherwood oak reproduction	PG 3		STRUCTURA 402 Havana oak reproduction	PG 3		STRUCTURA 405 Sierra oak reproduction	PG 3		STRUCTURA 403 Nero oak reproduction	PG 3		TOUCH 332 Lacquered laminate, alpine white supermatt	PG 3		TOUCH 336 Lacquered laminate, ivory supermatt	PG 3

*Unser umfangreiches Sortiment an Innenausstattung und Zubehör finden Sie auf unserer Website.
*Please refer to our website for our extensive range of interior fittings and accessories.

Technische Änderungen, Liefermöglichkeiten, Irrtümer und drucktechnisch bedingte Farbabweichungen vorbehalten. Alle Einrichtungsbeispiele sind unverbindlich.
All rights to technical alterations, delivery possibilities, errors and printing-related colour deviations are reserved. All furnishing examples are non-binding.

FRONTEN FRONTS

Fronten, die mit dem LINE N-Logo versehen sind, sind auch als grifflose Planungen lieferbar.
 Fronts marked with the LINE N logo are also available as handleless designs.

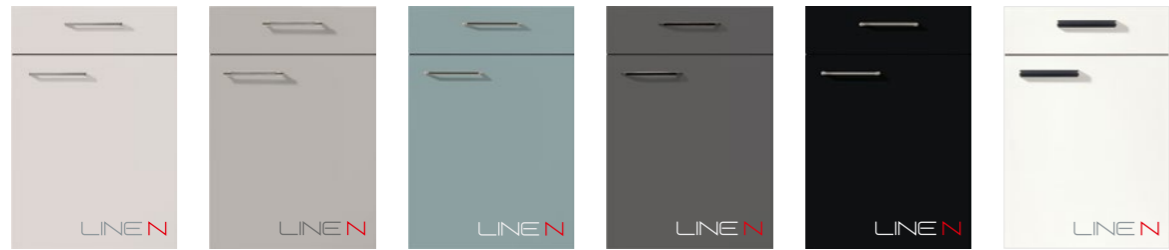

TOUCH 338 PG 3 Lacklaminat, Seidengrau supermatt	TOUCH 341 PG 3 Lacklaminat, Steingrau supermatt	TOUCH 337 PG 3 Lacklaminat, Aqua supermatt	TOUCH 334 PG 3 Lacklaminat, Schiefergrau supermatt	TOUCH 340 PG 3 Lacklaminat, Schwarz supermatt	FLASH 503 PG 3 Lacklaminat, Alpinweiß Hochglanz
TOUCH 338 PG 3 Lacquered laminate, satin grey supermatt	TOUCH 341 PG 3 Lacquered laminate, stone grey supermatt	TOUCH 337 PG 3 Lacquered laminate, aqua supermatt	TOUCH 334 PG 3 Lacquered laminate, slate grey supermatt	TOUCH 340 PG 3 Lacquered laminate, black supermatt	FLASH 503 PG 3 Lacquered laminate, alpine white high gloss

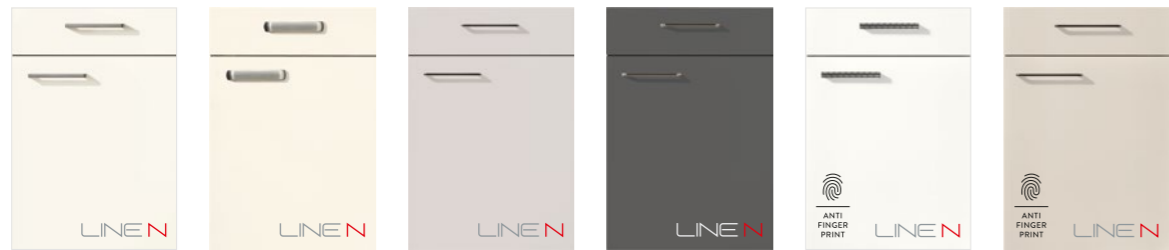

FLASH 450 PG 3 Lacklaminat, Weiß Hochglanz	FLASH 452 PG 3 Lacklaminat, Magnolia Hochglanz	FLASH 455 PG 3 Lacklaminat, Seidengrau Hochglanz	FLASH 453 PG 3 Lacklaminat, Schiefergrau Hochglanz	EASYTOUCH 967 PG 4 Lacklaminat, Alpinweiß ultramatt	EASYTOUCH 969 PG 4 Lacklaminat, Sand ultramatt
FLASH 450 PG 3 Lacquered laminate, white high gloss	FLASH 452 PG 3 Lacquered laminate, ivory high gloss	FLASH 455 PG 3 Lacquered laminate, satin grey high gloss	FLASH 453 PG 3 Lacquered laminate, slate grey high gloss	EASYTOUCH 967 PG 4 Lacquered laminate, alpine white ultra matt	EASYTOUCH 969 PG 4 Lacquered laminate, sand ultra matt



EASYTOUCH 963 PG 4 Lacklaminat, Rostrot ultramatt	EASYTOUCH 961 PG 4 Lacklaminat, Grafit schwarz ultramatt	STONEART 304 PG 4 Schiefer steingrau Nachbildung	STONEART 303 PG 4 Grauschiefer Nachbildung	INOX 216 PG 4 Lacklaminat, Stahl gebürstet Nachbildung	FASHION 168 PG 4 Lack, Alpinweiß matt
EASYTOUCH 963 PG 4 Lacquered laminate, rust red ultra matt	EASYTOUCH 961 PG 4 Lacquered laminate, graphite black ultra matt	STONEART 304 PG 4 Stone grey slate reproduction	STONEART 303 PG 4 Grey slate reproduction	INOX 216 PG 4 Lacquered laminate, brushed steel reproduction	FASHION 168 PG 4 Lacquer, honed alpine white



FASHION 173 PG 4 Lack, Weiß matt	FASHION 175 PG 4 Lack, Magnolia matt	FASHION 171 PG 4 Lack, Seidengrau matt	FASHION 165 PG 4 Lack, Steingrau matt	FOCUS 470 PG 4 Lack, Alpinweiß Ultra-Hochglanz	FOCUS 460 PG 4 Lack, Weiß Ultra-Hochglanz
FASHION 173 PG 4 Lacquer, honed white	FASHION 175 PG 4 Lacquer, honed ivory	FASHION 171 PG 4 Lacquer, honed satin grey	FASHION 165 PG 4 Lacquer, honed stone grey	FOCUS 470 PG 4 Lacquer, alpine white ultra high gloss	FOCUS 460 PG 4 Lacquer, white ultra high gloss



FOCUS 462 PG 4 Lack, Magnolia Ultra-Hochglanz	FOCUS 467 PG 4 Lack, Sand Ultra-Hochglanz	INLINE 551 PG 5 Lack, Alpinweiß matt	CREDO 764 PG 6 Lacklaminat, Alpinweiß	CASCADA 774 PG 7 Lacklaminat, Weiß	CASCADA 772 PG 7 Lacklaminat, Steingrau
FOCUS 462 PG 4 Lacquer, ivory ultra high gloss	FOCUS 467 PG 4 Lacquer, sand ultra high gloss	INLINE 551 PG 5 Lacquer, honed alpine white	CREDO 764 PG 6 Lacquered laminate, alpine white	CASCADA 774 PG 7 Lacquered laminate, white	CASCADA 772 PG 7 Lacquered laminate, stone grey



CASCADA 776 PG 7 Lacklaminat, Schilf	NORDIC 782 PG 7 Lack, Weiß matt	SYLT 847 PG 7 Lack, Alpinweiß matt	SYLT 849 PG 7 Lack, Magnolia matt	SYLT 851 PG 7 Lack, Schwarz matt	CASTELLO 390 PG 8 Magnolia gewischt
CASCADA 776 PG 7 Lacquered laminate, reed green	NORDIC 782 PG 7 Lacquer, honed white	SYLT 847 PG 7 Lacquer, honed alpine white	SYLT 849 PG 7 Lacquer, honed ivory	SYLT 851 PG 7 Lacquer, honed black	CASTELLO 390 PG 8 Washed ivory

















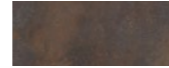



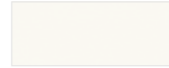











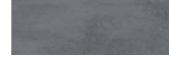

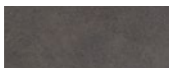





LUX 817 PG 9 Lack, Alpinweiß Hochglanz	LUX 814 PG 9 Lack, Weiß Hochglanz	LUX 816 PG 9 Lack, Magnolia Hochglanz	LUX 819 PG 9 Lack, Seidengrau Hochglanz	LUX 823 PG 9 Lack, Schiefergrau Hochglanz	PURA 834 PG 9 Lack, Weiß Hochglanz
LUX 817 PG 9 Lacquer, alpine white high gloss	LUX 814 PG 9 Lacquer, white high gloss	LUX 816 PG 9 Lacquer, ivory high gloss	LUX 819 PG 9 Lacquer, satin grey high gloss	LUX 823 PG 9 Lacquer, slate grey high gloss	PURA 834 PG 9 Lacquer, white high gloss



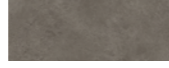

CHALET 883 PG 9 Lack, Magnolia matt	CHALET 881 PG 9 Lack, Sand matt	YORK 905 PG 9 Echtholz, Magnolia lackiert	YORK 901 PG 9 Echtholz, Seidengrau lackiert	ARTIS 937 PG 10 Glasoptik, Titanio matt
CHALET 883 PG 9 Lacquer, honed ivory	CHALET 881 PG 9 Lacquer, honed sand	YORK 905 PG 9 Genuine wood, lacquered ivory	YORK 901 PG 9 Genuine wood, lacquered satin grey	ARTIS 937 PG 10 Glass appearance, Titanio matt

Technische Änderungen, Liefermöglichkeiten, Irrtümer und drucktechnisch bedingte Farbabweichungen vorbehalten. Alle Einrichtungsbeispiele sind unverbindlich.
 All rights to technical alterations, delivery possibilities, errors and printing-related colour deviations are reserved. All furnishing examples are non-binding.

ARBEITSPLATTENEKORE WORKTOP DÉCORS

 066 Schiefer Nachbildung 066 Slate décor reproduction	 070* Seidengrau 070* Satin grey	 078 Eiche San Remo Nachbildung 078 Sanremo oak reproduction	 089* Steingrau 089* Stone grey	 097 Eiche Havanna Nachbildung 097 Havana oak reproduction	 117 Copper Vintage Nachbildung 117 Vintage Copper décor
 123 Eiche Virginia Nachbildung 123 Virginia oak reproduction	 124* Nussbaum Nachbildung 124* Walnut reproduction	 149* Beton Terragrau Nachbildung 149* Concrete Terra grey reproduction	 192 Eiche Provence Nachbildung 192 Oak Provence reproduction	 193* Alpinweiß 193* Alpine white	 194* Schiefergrau 194* Slate grey
 198 Eiche Sierra Nachbildung 198 Sierra oak reproduction	 215 Stromboli hell Nachbildung 215 Strombolian light reproduction	 220 Arizona Pine Nachbildung 220 Arizona pine reproduction	 225 Stammeiche Nachbildung 225 Stem oak reproduction	 226 Dekor Metal Art Nachbildung 226 Metal art décor	 265 Rusty Plates Nachbildung 265 Rusty plates reproduction
 266 Caledonia 266 Caledonia	 272 Balkeneiche Nachbildung 272 Timber oak reproduction	 273 Carrara Nachbildung 273 Carrara marble reproduction	 274 Marmor Teramo Nachbildung 274 Teramo marble reproduction	 319 Dekor Oxid 319 Oxid décor	 330* Beton grau Nachbildung 330* Concrete grey reproduction
 344* Granit schwarz geflammt Nachbildung 344* Black granite décor	 345 Eiche Yukon Nachbildung 345 Yukon oak reproduction	 347 Taxus Nachbildung 347 Taxus reproduction	 352 Eiche Halifax Nachbildung 352 Sherwood oak reproduction	 353* Weißbeton Nachbildung 353* White Concrete reproduction	 354* Beton schiefergrau Nachbildung 354* Concrete Slate Grey reproduction
 355* Ferro Bronze Nachbildung 355* Ferro bronze décor	 356 Endgrain Oak Nachbildung 356 Endgrain oak reproduction	 366* Schwarz strukturiert 366* Black textured	 376* Limestone Nachbildung 376* Limestone reproduction	 378 Schwarzbeton Nachbildung 378 Black Concrete reproduction	 379 Eiche Somerset Nachbildung 379 Somerset oak reproduction
 393 Vintage Oak Nachbildung 393 Vintage oak reproduction	 394 Travertin sandbeige Nachbildung 394 Champagne travertine reproduction	 395 Verso Nachbildung 395 Verso reproduction	 396 Terrazzo grau Nachbildung 396 Grey terrazzo reproduction	 Arbeitsplatte APN mit N-Kante Worktop APN with N edge	 Arbeitsplatte APD mit Dekorkante Worktop APD with décor edge

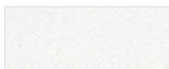
QUARZSTEIN QUARTZ STONE







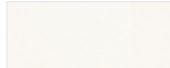
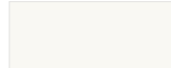
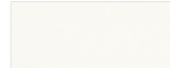
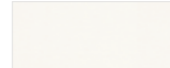
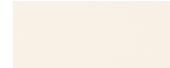
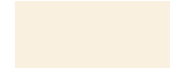

 806** Quarzstein Epic White 806** Quartz stone Epic White	 802** Quarzstein Epic Raw 802** Quartz stone Epic Raw	 804** Quarzstein Epic Black 804** Quartz stone Epic Black
--	--	---

** Auch als 12 mm starke Arbeitsplatte lieferbar.
** Also available as 12 mm thick worktop.

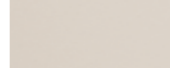









XTRA

 364* Dolerit Nachbildung 364* Basalt reproduction	 369* Schiefer steingrau Nachbildung 369* Stone grey slate reproduction	 373* Grauschiefer Nachbildung 373* Grey slate reproduction	 367* Eiche Artisan Nachbildung 367* Artisan oak reproduction	
--	---	---	--	---

KORPUSDEKORE CARCASE DÉCORS











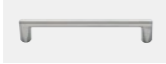

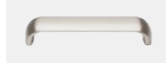
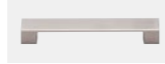

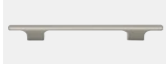

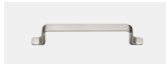

 193 Alpinweiß 193 Alpine white	 060 Alpinweiß Glanz 060 Alpine white gloss	 106 Weiß 106 White	 022 Weiß Glanz 022 White gloss	 120 Magnolia matt 120 Ivory matt	 116 Magnolia Glanz 116 Ivory gloss
 070 Seidengrau 070 Satin grey	 089 Steingrau 089 Stone grey	 122 Sand 122 Sand	 194 Schiefergrau 194 Slate grey	 127 Schwarz 127 Black	 123 Eiche Virginia Nachbildung 123 Virginia oak reproduction
 078 Eiche San Remo Nachbildung 078 Sanremo oak reproduction	 198 Eiche Sierra Nachbildung 198 Sierra oak reproduction	 097 Eiche Havanna Nachbildung 097 Havana oak reproduction			

COLOR CONCEPT COLOR CONCEPT

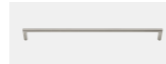

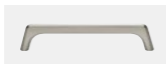
 241 Sonnengelb 241 Maize Yellow	 038 Schilf 038 Reed green	 248 Farn 248 Fern	 254 Aqua 254 Aqua	 265 Rusty Plates Nachbildung 265 Rusty plates reproduction	 266 Caledonia 266 Caledonia
 272 Balkeneiche Nachbildung 272 Timber oak reproduction	 273 Carrara Nachbildung 273 Carrara marble reproduction	 274 Marmor Teramo Nachbildung 274 Teramo marble reproduction	 355 Ferro Bronze Nachbildung 355 Ferro bronze décor		

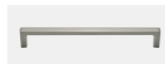
GRIFFAUSWAHL HANDLE SELECTION

Griffe Edelstahlfarbig Handles in stainless steel finish

					
019* Metallgriff Edelstahlfarbig	042 Metallgriff Edelstahlfarbig	062 Metallgriff Edelstahlfarbig	067 Metallgriff Edelstahlfarbig	069 Metallgriff Edelstahlfarbig	077 Metallgriff Edelstahlfarbig
019* Metal handle Stainless steel finish	042 Metal handle Stainless steel finish	062 Metal handle Stainless steel finish	067 Metal handle Stainless steel finish	069 Metal handle Stainless steel finish	077 Metal handle Stainless steel finish
					
098 Metallgriff Nickel matt	121 Metallgriff Edelstahlfarbig	183 Metallgriff Edelstahlfarbig	186 Metallgriff Edelstahlfarbig	218 Metallgriff Edelstahlfarbig / Chrom Glanz	221 Metallgriff Edelstahlfarbig
098 Metal handle Matt nickel	121 Metal handle Stainless steel finish	183 Metal handle Stainless steel finish	186 Metal handle Stainless steel finish	218 Metal handle Stainless steel finish / Brilliant chrome	221 Metal handle Stainless steel finish
					
237 Metallgriff Edelstahlfarbig	263 Metallgriff Edelstahlfarbig	279 Metallgriff Edelstahlfarbig	331 Metallgriff Edelstahlfarbig	408 Metallgriff Edelstahlfarbig	409* Bügelgriff Edelstahlfarbig
237 Metal handle Stainless steel finish	263 Metal handle Stainless steel finish	279 Metal handle Stainless steel finish	331 Metal handle Stainless steel finish	408 Metal handle Stainless steel finish	409* Bow handle Stainless steel finish
					
544 Metallgriff Edelstahlfarbig	552 Metallgriff Edelstahlfarbig	602 Metallgriff Edelstahlfarbig	608 Metallgriff Edelstahlfarbig	708 Metallgriff Edelstahlfarbig	801 Metallgriff Edelstahlfarbig
544 Metal handle Stainless steel finish	552 Metal handle Stainless steel finish	602 Metal handle Stainless steel finish	608 Metal handle Stainless steel finish	708 Metal handle Stainless steel finish	801 Metal handle Stainless steel finish

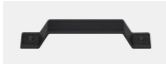
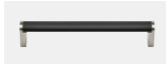

Griffe Anthrazit / Schwarz Handles in Anthracite / Black

			
563 Metallgriff Schwarz / Edelstahlfarbig	570 Metallgriff Schwarz	595 Metallgriff Schwarz / Edelstahlfarbig	616 Gusseisengriff Schwarz
563 Metal handle Black / Stainless steel finish	570 Metal handle Black	595 Metal handle Black / Stainless steel finish	616 Cast iron handle Black















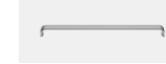
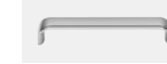

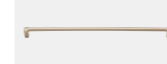

Knöpfe Knobs

		
610 Gusseisenknopf Schwarz	677 Metallknopf Edelstahlfarbig	679 Metallknopf Schwarz
610 Cast iron knob Black	677 Metal knob Stainless steel finish	679 Metal knob Black











Holzgriffe Wooden handles

	
199* Holzgriff Eiche	737* Holz-Metallgriff Eiche / Schwarz
199* Wooden handle Oak	737* Wood / Metal handle Oak / Black





Griffe mit Effektveredelung Handles with effect finishing

					
088 Metallgriff Anthrazit gebürstet	099 Metallgriff Industrial Style	118 Metallgriff Altsilberfarbig	119 Metallgriff Altsilberfarbig	190* Bügelgriff Chrom Glanz	192 Metallgriff Chrom Glanz
088 Metal handle Brushed anthracite	099 Metal handle Industrial Style	118 Metal handle Antique silver colour	119 Metal handle Antique silver colour	190* Bow handle Brilliant chrome	192 Metal handle Brilliant chrome
					
222 Metallgriff Goldfarbig	223* Bügelgriff Goldfarbig	271 Metallgriff Titanfarbig	280 Metallgriff Alteisenfarbig	284 Metallgriff Altsilberfarbig	358 Metallgriff Titanfarbig
222 Metal handle Gold-coloured	223* Bow handle Gold-coloured	271 Metal handle Titanium-coloured	280 Metal handle Antique iron colour	284 Metal handle Antique silver colour	358 Metal handle Titanium-coloured
					
498 Metallgriff Chrom Glanz	499* Bügelgriff Chrom Glanz	509 Metallgriff Grau	511 Metallgriff Titanfarbig	514* Bügelgriff Titanfarbig	515* Bügelgriff Titanfarbig
498 Metal handle Brilliant chrome	499* Bow handle Brilliant chrome	509 Metal handle Grey	511 Metal handle Titanium-coloured	514* Bow handle Titanium-coloured	515* Bow handle Titanium-coloured
					
799 Metallgriff Schwarzchrom					
799 Metal handle Chromed black					

Griffleisten Bar handles

					
240* Griffleiste Schwarz	300* Griffleiste Edelstahlfarbig	350* Griffleiste Edelstahlfarbig	430* Griffleiste Edelstahlfarbig	550* Griffleiste Edelstahlfarbig	600* Griffleiste Schwarz
240* Bar handle Black	300* Bar handle Stainless steel finish	350* Bar handle Stainless steel finish	430* Bar handle Stainless steel finish	550* Bar handle Stainless steel finish	600* Bar handle Black
					
690* Griffleiste Alpenweiß	710* Griffleiste Steingrau	730* Griffleiste Schiefergrau	760* Griffleiste Edelstahlfarbig	870* Griffleiste Schwarz	
690* Bar handle Alpine white	710* Bar handle Stone grey	730* Bar handle Slate grey	760* Bar handle Stainless steel finish	870* Bar handle Black	

Relingstangen Railing handles

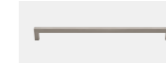
				
370* Relingstange Edelstahlfarbig	620* Relingstange Schwarz	650* Relingstange Edelstahlfarbig	900* Relingstange Edelstahlfarbig	930* Relingstange Edelstahlfarbig
370* Railing handle Stainless steel finish	620* Railing handle Black	650* Railing handle Stainless steel finish	900* Railing handle Stainless steel finish	930* Railing handle Stainless steel finish

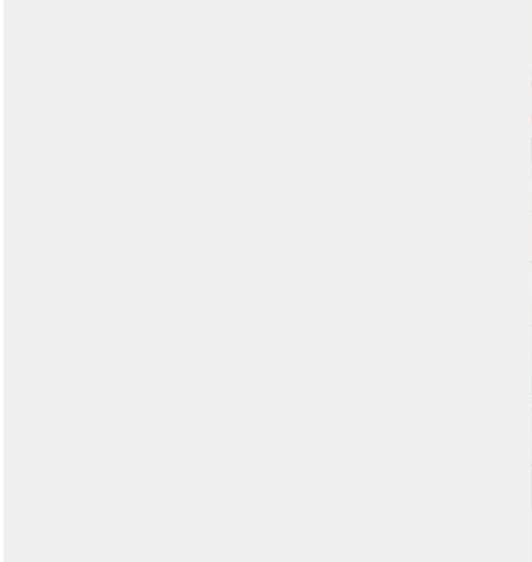

Qualität made in Germany Quality made in Germany

Ausgesuchte Materialien, exzellente Verarbeitung, Perfektion bis ins Detail: Unsere Bäder werden nach höchsten Qualitätskriterien entwickelt und gefertigt. Dabei produzieren wir ausschließlich am Standort Deutschland.

Bevor unsere Produkte in Serie gehen, werden alle eingesetzten Materialien in umfangreichen Testverfahren im Labor auf eine Mindestlebensdauer von 15 Jahren geprüft und durch internationale, unabhängige Institute kontrolliert und zertifiziert. Denn die Zufriedenheit unserer Kunden ist für uns der höchste Maßstab.

Selected materials, excellent workmanship, perfection right down to the finest detail: our bathrooms are developed and manufactured according to the highest quality criteria. Our products are made exclusively in Germany.

Before our products go into production, all the materials used are subjected to extensive test procedures in the laboratory for a minimum service life of 15 years and inspected and certified by independent international institutes. After all, our customers' satisfaction is our benchmark.

